



Service Manual

Lexmark™ E260d, E260dn

4513-220

4513-230

- ***Table of contents***
- ***Start diagnostics***
- ***Safety and notices***
- ***Trademarks***
- ***Index***

LEXMARK™

Lexmark and Lexmark with diamond design are trademarks of Lexmark International, Inc., registered in the United States and/or other countries.

Edition: September 29, 2008

The following paragraph does not apply to any country where such provisions are inconsistent with local law:

LEXMARK INTERNATIONAL, INC. PROVIDES THIS PUBLICATION "AS IS" WITHOUT WARRANTY OF ANY KIND, EITHER EXPRESS OR IMPLIED, INCLUDING, BUT NOT LIMITED TO, THE IMPLIED WARRANTIES OF MERCHANTABILITY OR FITNESS FOR A PARTICULAR PURPOSE. Some states do not allow disclaimer of express or implied warranties in certain transactions; therefore, this statement may not apply to you.

This publication could include technical inaccuracies or typographical errors. Changes are periodically made to the information herein; these changes will be incorporated in later editions. Improvements or changes in the products or the programs described may be made at any time.

Comments may be addressed to Lexmark International, Inc., Department D22X/002-1, 740 West New Circle Road, Lexington, Kentucky 40550, U.S.A or e-mail at ServiceInfoAndTraining@Lexmark.com. Lexmark may use or distribute any of the information you supply in any way it believes appropriate without incurring any obligation to you.

References in this publication to products, programs, or services do not imply that the manufacturer intends to make these available in all countries in which it operates. Any reference to a product, program, or service is not intended to state or imply that only that product, program, or service may be used. Any functionally equivalent product, program, or service that does not infringe any existing intellectual property right may be used instead. Evaluation and verification of operation in conjunction with other products, programs, or services, except those expressly designated by the manufacturer, are the user's responsibility.

Lexmark, Lexmark with diamond design, and MarkVision are trademarks of Lexmark International, Inc., registered in the United States and/or other countries.

PictureGrade is a trademark of Lexmark International, Inc.

PCL® is a registered trademark of the Hewlett-Packard Company.

All other trademarks are the property of their respective owners.

**© 2008 Lexmark International, Inc.
All rights reserved.**

UNITED STATES GOVERNMENT RIGHTS

This software and any accompanying documentation provided under this agreement are commercial computer software and documentation developed exclusively at private expense.

Table of Contents

Table of Contents	iii
Notices and safety information	vii
Laser notice	vii
Safety information	xiii
Preface	xvi
Conventions	xvi
General information	1-1
Maintenance approach	1-1
Overview of the operator panel	1-2
Specifications	1-3
Memory	1-3
Print quality settings	1-3
Connectivity and compatibility	1-4
Media trays and supply capacity	1-5
Types of print media	1-6
Tips on preventing jams	1-7
Paper path	1-7
Tools	1-8
Acronyms	1-9
Diagnostics information	2-1
Start	2-1
Overview of the operator panel	2-2
Power-On Self Test (POST) sequence	2-2
Light patterns and error messages	2-3
Common primary light patterns	2-4
Primary codes	2-7
Common secondary light patterns	2-16
Secondary error codes	2-18
Service codes	2-28
Messages and error codes	2-36
User attendance messages	2-36
Paper jam error codes (200-series)	2-36
Service error codes	2-40
Diagram of the printer menus	2-43
Symptom tables	2-44
POST symptom table	2-44
Printer symptom table	2-45
Service checks	2-46
Controller board service check	2-46
Cooling fan service check	2-47
Cover interlock switch service check	2-47
Dead machine service check	2-48
Fuser service check	2-48
LVPS/HVPS service check	2-49
Main motor service check	2-49
Operator panel service check	2-50
Paper feed service checks	2-50

Parallel or USB port service check	2-52
Print quality service checks	2-53
Printhead service check	2-60
Transfer roll service check	2-60
Diagnostic aids	3-1
Accessing service menus	3-1
Printing menus	3-1
Moving around the menu	3-1
Configuration menu selections	3-4
Utilities	3-4
Setup	3-5
Parallel	3-5
USB	3-6
Network	3-7
Diagnostics mode selections	3-8
Adjustment procedures	3-9
Repair information	4-1
Handling ESD-sensitive parts	4-1
Removal procedures	4-2
ACM pick tire roller removal	4-3
Bezel removal	4-5
Controller board removal	4-6
Cover open sensor	4-8
Door mount removal	4-9
Duplex removal	4-11
Duplex/main motor gear drive interface removal	4-13
Fan removal	4-16
Front access door removal	4-17
Fuser removal	4-20
Left side cover removal	4-23
Lower front cover removal	4-25
LVPS/HVPS removal	4-26
Main motor gear drive removal	4-29
Manual feed clutch removal	4-31
Media ACM ASM feeder removal	4-35
Media feed clutch with cable removal	4-38
Media manual input sensor removal	4-40
Nameplate removal	4-43
Operator panel removal	4-44
Paper input and duplex sensor assembly removal	4-45
Printhead removal	4-46
Rear door and rear cover removal	4-47
Rear exit guide assembly with sensor and reversing solenoid removal	4-49
Right side cover assembly removal	4-51
Top cover assembly removal	4-53
Transfer roll removal	4-55
Wear strip (tray 1 and 250-sheet tray 2) removal	4-56
Wear strip (550-sheet tray 2) removal	4-57
Locations and connections	5-1
Locations	5-1
Front view	5-1
Rear view	5-1
Controller board connector pin values	5-2

Preventive maintenance	6-1
Safety inspection guide	6-1
Lubrication specifications	6-1
Parts catalog	7-1
How to use this parts catalog	7-1
Index	I-1
Part number index	I-3

Notices and safety information

The following laser notice labels may be affixed to this printer.

Laser notice

The printer is certified in the U.S. to conform to the requirements of DHHS 21 CFR Subchapter J for Class I (1) laser products, and elsewhere is certified as a Class I laser product conforming to the requirements of IEC 60825-1.

Class I laser products are not considered to be hazardous. The printer contains internally a Class IIIb (3b) laser that is nominally a 7 milliwatt gallium arsenide laser operating in the wavelength region of 655-675 nanometers. The laser system and printer are designed so there is never any human access to laser radiation above a Class I level during normal operation, user maintenance, or prescribed service condition.

Laser

Der Drucker erfüllt gemäß amtlicher Bestätigung der USA die Anforderungen der Bestimmung DHHS (Department of Health and Human Services) 21 CFR Teil J für Laserprodukte der Klasse I (1). In anderen Ländern gilt der Drucker als Laserprodukt der Klasse I, der die Anforderungen der IEC (International Electrotechnical Commission) 60825-1 gemäß amtlicher Bestätigung erfüllt.

Laserprodukte der Klasse I gelten als unschädlich. Im Inneren des Druckers befindet sich ein Laser der Klasse IIIb (3b), bei dem es sich um einen Galliumarsenlaser mit 7 Milliwatt handelt, der Wellen der Länge 655-675 Nanometer ausstrahlt. Das Lasersystem und der Drucker sind so konzipiert, daß im Normalbetrieb, bei der Wartung durch den Benutzer oder bei ordnungsgemäßer Wartung durch den Kundendienst Laserbestrahlung, die Klasse I übersteigen würde, Menschen keinesfalls erreicht.

Avis relatif à l'utilisation de laser

Pour les Etats-Unis : cette imprimante est certifiée conforme aux provisions DHHS 21 CFR alinéa J concernant les produits laser de Classe I (1). Pour les autres pays : cette imprimante répond aux normes IEC 60825-1 relatives aux produits laser de Classe I.

Les produits laser de Classe I sont considérés comme des produits non dangereux. Cette imprimante est équipée d'un laser de Classe IIIb (3b) (arséniure de gallium d'une puissance nominale de 7 milliwatts) émettant sur des longueurs d'onde comprises entre 655 et 675 nanomètres. L'imprimante et son système laser sont conçus pour impossible, dans des conditions normales d'utilisation, d'entretien par l'utilisateur ou de révision, l'exposition à des rayonnements laser supérieurs à des rayonnements de Classe I.

Avvertenze sui prodotti laser

Questa stampante è certificata negli Stati Uniti per essere conforme ai requisiti del DHHS 21 CFR Sottocapitolo J per i prodotti laser di classe 1 ed è certificata negli altri Paesi come prodotto laser di classe 1 conforme ai requisiti della norma CEI 60825-1.

I prodotti laser di classe non sono considerati pericolosi. La stampante contiene al suo interno un laser di classe IIIb (3b) all'arseniuro di gallio della potenza di 7mW che opera sulla lunghezza d'onda compresa tra 655 e 675 nanometri. Il sistema laser e la stampante sono stati progettati in modo tale che le persone a contatto con la stampante, durante il normale funzionamento, le operazioni di servizio o quelle di assistenza tecnica, non ricevano radiazioni laser superiori al livello della classe 1.

Avisos sobre el láser

Se certifica que, en los EE.UU., esta impresora cumple los requisitos para los productos láser de Clase I (1) establecidos en el subcapítulo J de la norma CFR 21 del DHHS (Departamento de Sanidad y Servicios) y, en los demás países, reúne todas las condiciones expuestas en la norma IEC 60825-1 para productos láser de Clase I (1).

Los productos láser de Clase I no se consideran peligrosos. La impresora contiene en su interior un láser de Clase IIIb (3b) de arseniuro de galio de funcionamiento nominal a 7 milivatios en una longitud de onda de 655 a 675 nanómetros. El sistema láser y la impresora están diseñados de forma que ninguna persona pueda verse afectada por ningún tipo de radiación láser superior al nivel de la Clase I durante su uso normal, el mantenimiento realizado por el usuario o cualquier otra situación de servicio técnico.

Declaração sobre Laser

A impressora está certificada nos E.U.A. em conformidade com os requisitos da regulamentação DHHS 21 CFR Subcapítulo J para a Classe I (1) de produtos laser. Em outros locais, está certificada como um produto laser da Classe I, em conformidade com os requisitos da norma IEC 60825-1.

Os produtos laser da Classe I não são considerados perigosos. Internamente, a impressora contém um produto laser da Classe IIIb (3b), designado laser de arseneto de potássio, de 7 milliwatts, operando numa faixa de comprimento de onda entre 655 e 675 nanómetros. O sistema e a impressora laser foram concebidos de forma a nunca existir qualquer possibilidade de acesso humano a radiação laser superior a um nível de Classe I durante a operação normal, a manutenção feita pelo utilizador ou condições de assistência prescritas.

Laserinformatie

De printer voldoet aan de eisen die gesteld worden aan een laserprodukt van klasse I. Voor de Verenigde Staten zijn deze eisen vastgelegd in DHHS 21 CFR Subchapter J, voor andere landen in IEC 60825-1.

Laserprodukten van klasse I worden niet als ongevaarlijk aangemerkt. De printer is voorzien van een laser van klasse IIIb (3b), dat wil zeggen een gallium arsenide-laser van 7 milliwatt met een golflengte van 655-675 nanometer. Het lasergedeelte en de printer zijn zo ontworpen dat bij normaal gebruik, bij onderhoud of reparatie conform de voorschriften, nooit blootstelling mogelijk is aan laserstraling boven een niveau zoals voorgeschreven is voor klasse 1.

Lasermeddelelse

Printeren er godkendt som et Klasse I-laserprodukt, i overensstemmelse med kravene i IEC 60825-1.

Klasse I-laserprodukter betragtes ikke som farlige. Printeren indeholder internt en Klasse IIIB (3b)-laser, der nominelt er en 7 milliwatt galliumarsenid laser, som arbejder på bølgelængdeområdet 655-675 nanometer. Lasersystemet og printeren er udformet således, at mennesker aldrig udsættes for en laserstråling over Klasse I-niveau ved normal drift, brugervedligeholdelse eller obligatoriske servicebetingelser.

Laserilmoitus

Tämä tulostin on sertifioitu Yhdysvalloissa DHHS 21 CFR Subchapter J -standardin mukaiseksi luokan I (1) - lasertuotteeksi ja muualla IEC 60825-1 -standardin mukaiseksi luokan I lasertuotteeksi.

Luokan I lasertuotteita ei pidetä haitallisina. Tulostimen sisällä on luokan IIIb (3b) laser, joka on nimellisteholtaan 7 mW:n galliumarsenidilaser ja toimii 655 - 675 nanometrin aallonpituuksilla. Laserjärjestelmä ja tulostin ovat rakenteeltaan sellaisia, että käyttäjä ei joudu alttiiksi luokkaa 1 suuremmalle säteilylle normaalin käytön, ylläpidon tai huollon aikana.

Huomautus laserlaitteesta

Tämä kirjoitin on Yhdysvalloissa luokan I (1) laserlaitteiden DHHS 21 CFR Subchapter J -määrityksen mukainen ja muualla luokan I laserlaitteiden IEC 60825-1 -määrityksen mukainen.

Luokan I laserlaitteiden ei katsota olevan vaarallisia käyttäjälle. Kirjoittimessa on sisäinen luokan IIIb (3b) 7 milliwatin galliumarsenidilaser, joka toimii aaltoalueella 655 - 675 nanometriä. Laserjärjestelmä ja kirjoitin on suunniteltu siten, että käyttäjä ei altistu luokan I määräytyksiä voimakkaammalle säteilylle kirjoittimen normaalin toiminnan, käyttäjän tekemien huoltotoimien tai muiden huoltotoimien yhteydessä.

VARO! Avattaessa ja suojalukitus ohitettaessa olet alttiina näkymättömälle lasersäteilylle. Älä katso säteeseen.

WARNING! Osynlig laserstrålning när denna del är öppnad och spärren är urkopplad. Betrakta ej strålen.

Laser-notis

Denna skrivare är i USA certifierad att motsvara kraven i DHHS 21 CFR, underparagraf J för laserprodukter av Klass I (1). I andra länder uppfyller skrivaren kraven för laserprodukter av Klass I enligt kraven i IEC 60825-1.

Laserprodukter i Klass I anses ej hälsovådliga. Skrivaren har en inbyggd laser av Klass IIIb (3b) som består av en laserenhet av gallium-arsenid på 7 milliwatt som arbetar i våglängdsområdet 655-675 nanometer. Lasersystemet och skrivaren är utformade så att det aldrig finns risk för att någon person utsätts för laserstrålning över Klass I-nivå vid normal användning, underhåll som utförs av användaren eller annan föreskriven serviceåtgärd.

Laser-melding

Skriveren er godkjent i USA etter kravene i DHHS 21 CFR, underkapittel J, for klasse I (1) laserprodukter, og er i andre land godkjent som et Klasse I-laserprodukt i samsvar med kravene i IEC 60825-1.

Klasse I-laserprodukter er ikke å betrakte som farlige. Skriveren inneholder internt en klasse IIIb (3b)-laser, som består av en gallium-arsenlaserenhet som avgir stråling i bølgelengdeområdet 655-675 nanometer. Lasersystemet og skriveren er utformet slik at personer aldri utsettes for laserstråling ut over klasse I-nivå under vanlig bruk, vedlikehold som utføres av brukeren, eller foreskrevne serviceoperasjoner.

Avís sobre el Làser

Segons ha estat certificat als Estats Units, aquesta impressora compleix els requisits de DHHS 21 CFR, apartat J, pels productes làser de classe I (1), i segons ha estat certificat en altres llocs, és un producte làser de classe I que compleix els requisits d'IEC 60825-1.

Els productes làser de classe I no es consideren perillosos. Aquesta impressora conté un làser de classe IIIb (3b) d'arseniür de gal.li, nominalment de 7 mil.liwats, i funciona a la regió de longitud d'ona de 655-675 nanòmetres. El sistema làser i la impressora han sigut concebuts de manera que mai hi hagi exposició a la radiació làser per sobre d'un nivell de classe I durant una operació normal, durant les tasques de manteniment d'usuari ni durant els serveis que satisfacin les condicions prescrites.

レーザーに関するお知らせ

このプリンターは、米国ではDHHS 21 CFRサブチャプターJのクラスI (1)の基準を満たしたレーザー製品であることが証明されています。また米国以外ではIEC 825の基準を満たしたクラスIのレーザー製品であることが証明されています。

クラスIのレーザー製品には危険性はないと考えられています。このプリンターはクラスIIIb (3b)のレーザーを内蔵しています。このレーザーは、波長が770 ~ 795ナノメートルの範囲で、通常5ミリワットのガリウム砒化物を放射するレーザーです。このレーザーシステムとプリンターは、通常の操作、ユーザのメンテナンス、規定された修理においては、人体がクラスIのレベル以上のレーザー放射に晒されることのないよう設計されています。

注意：

本打印机被美国认证合乎 DHHS 21 CFR Subchapter I 对分类 I (1) 激光产品的标准，而在其他地区则被认证合乎 IEC 825 的标准。

分类 I 激光产品一般认为不具危险性，本打印机内部含有分类 IIIb (3b) 的激光，在操作过程中会产生 5 毫瓦含镓及砷的微量激光，其波长范围在 770-795 nm 之间。本激光系统及打印机的设计，在一般操作、使用者维护或规定内的维修情况下，不会使人体接触分类 I 以上等级的辐射。

본프린터는 1등급 레이저 제품들에 대한 DHHS 21 CFR Subchapter 3의 규정을 준수하고 있음을 미국에서 인증받았으며, 그외의 나라에서도 IEC 825 규정을 준수하는 1등급 레이저 제품으로서 인증을 받았습니다.

1등급 레이저 제품들은 안전한 것으로 간주됩니다. 본 프린터는 5 밀리와트 갈륨 아르세나이드 레이저로서 770-795 나노미터의 파장대에서 활동하는 Class III (3b) 레이저를 내부에 갖고 있습니다. 본 레이저 시스템과 프린터는 정상 작동 중이나 유지 보수 중 또는 규정된 서비스 상태에서 상기의 Class I 수준의 레이저 방출에 사람이 절대 접근할 수 없도록 설계되어 있습니다.

Safety information

- The safety of this product is based on testing and approvals of the original design and specific components. The manufacturer is not responsible for safety in the event of use of unauthorized replacement parts.
- The maintenance information for this product has been prepared for use by a professional service person and is not intended to be used by others.
- There may be an increased risk of electric shock and personal injury during disassembly and servicing of this product. Professional service personnel should understand this and take necessary precautions.
-  **CAUTION:** When you see this symbol, there is a danger from hazardous voltage in the area of the product where you are working. Unplug the product before you begin, or use caution if the product must receive power in order to perform the task.

Consignes de sécurité

- La sécurité de ce produit repose sur des tests et des agrégations portant sur sa conception d'origine et sur des composants particuliers. Le fabricant n'assume aucune responsabilité concernant la sécurité en cas d'utilisation de pièces de rechange non agréées.
- Les consignes d'entretien et de réparation de ce produit s'adressent uniquement à un personnel de maintenance qualifié.
- Le démontage et l'entretien de ce produit pouvant présenter certains risques électriques, le personnel d'entretien qualifié devra prendre toutes les précautions nécessaires.
-  **ATTENTION :** Ce symbole indique la présence d'une tension dangereuse dans la partie du produit sur laquelle vous travaillez. Débranchez le produit avant de commencer ou faites preuve de vigilance si l'exécution de la tâche exige que le produit reste sous tension.

Norme di sicurezza

- La sicurezza del prodotto si basa sui test e sull'approvazione del progetto originale e dei componenti specifici. Il produttore non è responsabile per la sicurezza in caso di sostituzione non autorizzata delle parti.
- Le informazioni riguardanti la manutenzione di questo prodotto sono indirizzate soltanto al personale di assistenza autorizzato.
- Durante lo smontaggio e la manutenzione di questo prodotto, il rischio di subire scosse elettriche e danni alla persona è più elevato. Il personale di assistenza autorizzato deve, quindi, adottare le precauzioni necessarie.
-  **ATTENZIONE:** Questo simbolo indica la presenza di tensione pericolosa nell'area del prodotto. Scollegare il prodotto prima di iniziare o usare cautela se il prodotto deve essere alimentato per eseguire l'intervento.

Sicherheitshinweise

- Die Sicherheit dieses Produkts basiert auf Tests und Zulassungen des ursprünglichen Modells und bestimmter Bauteile. Bei Verwendung nicht genehmigter Ersatzteile wird vom Hersteller keine Verantwortung oder Haftung für die Sicherheit übernommen.
- Die Wartungsinformationen für dieses Produkt sind ausschließlich für die Verwendung durch einen Wartungsfachmann bestimmt.
- Während des Auseinandernehmens und der Wartung des Geräts besteht ein zusätzliches Risiko eines elektrischen Schlags und körperlicher Verletzung. Das zuständige Fachpersonal sollte entsprechende Vorsichtsmaßnahmen treffen.

-  **ACHTUNG:** Dieses Symbol weist auf eine gefährliche elektrische Spannung hin, die in diesem Bereich des Produkts auftreten kann. Ziehen Sie vor den Arbeiten am Gerät den Netzstecker des Geräts, bzw. arbeiten Sie mit großer Vorsicht, wenn das Produkt für die Ausführung der Arbeiten an den Strom angeschlossen sein muß.

Pautas de Seguridad

- La seguridad de este producto se basa en pruebas y aprobaciones del diseño original y componentes específicos. El fabricante no es responsable de la seguridad en caso de uso de piezas de repuesto no autorizadas.
- La información sobre el mantenimiento de este producto está dirigida exclusivamente al personal cualificado de mantenimiento.
- Existe mayor riesgo de descarga eléctrica y de daños personales durante el desmontaje y la reparación de la máquina. El personal cualificado debe ser consciente de este peligro y tomar las precauciones necesarias.
-  **PRECAUCIÓN:** este símbolo indica que el voltaje de la parte del equipo con la que está trabajando es peligroso. Antes de empezar, desenchufe el equipo o tenga cuidado si, para trabajar con él, debe conectarlo.

Informações de Segurança

- A segurança deste produto baseia-se em testes e aprovações do modelo original e de componentes específicos. O fabricante não é responsável pela segurança, no caso de uso de peças de substituição não autorizadas.
- As informações de segurança relativas a este produto destinam-se a profissionais destes serviços e não devem ser utilizadas por outras pessoas.
- Risco de choques eléctricos e ferimentos graves durante a desmontagem e manutenção deste produto. Os profissionais destes serviços devem estar avisados deste facto e tomar os cuidados necessários.
-  **CUIDADO:** Quando vir este símbolo, existe a possível presença de uma potencial tensão perigosa na zona do produto em que está a trabalhar. Antes de começar, desligue o produto da tomada eléctrica ou seja cuidadoso caso o produto tenha de estar ligado à corrente eléctrica para realizar a tarefa necessária.

Informació de Seguretat

- La seguretat d'aquest producte es basa en l'avaluació i aprovació del disseny original i els components específics.
El fabricant no es fa responsable de les qüestions de seguretat si s'utilitzen peces de recanvi no autoritzades.
- La informació pel manteniment d'aquest producte està orientada exclusivament a professionals i no està destinada a ningú que no ho sigui.
- El risc de xoc elèctric i de danys personals pot augmentar durant el procés de desmuntatge i de servei d'aquest producte. El personal professional ha d'estar-ne assabentat i prendre les mesures convenients.
-  **PRECAUCIÓ:** aquest símbol indica que el voltatge de la part de l'equip amb la qual esteu treballant és perillós. Abans de començar, desendolieu l'equip o extremeu les precaucions si, per treballar amb l'equip, l'heu de connectar.

안전 사항

- 본 제품은 원래 설계 및 특정 구성품에 대한 테스트 결과로 안정성이 입증된 것입니다. 따라서 무허가 교체부품을 사용하는 경우에는 제조업체에서 안전에 대한 책임을 지지 않습니다.
- 본 제품에 관한 유지 보수 설명서는 전문 서비스 기술자용으로 작성된 것이므로, 비전문가는 사용할 수 없습니다.
- 본 제품을 해체하거나 정비할 경우, 전기적인 충격을 받거나 상처를 입을 위험이 커집니다. 전문 서비스 기술자는 이 사실을 숙지하고, 필요한 예방 조치를 취하도록 하십시오.
-  **주의:** 이 표시는 해당영역에서 고압전류가 흐른다는 위험 표시입니다. 시작전에 플러그를 뽑으시거나, 주의를 기울여 주시기 바랍니다.

安全信息

- 本产品的安全性以原来设计和特定产品的测试结果和认证为基础。万一使用未经许可的替换部件，制造商不对安全性负责。
- 本产品的维护信息仅供专业服务人员使用，并不打算让其他人使用。
- 本产品在拆卸、维修时，遭受电击或人员受伤的危险性会增高，专业服务人员对这点必须有所了解，并采取必要的预防措施。
-  **切记:** 当您看到此符号时，说明在您工作的产品区域有危险电压的存在。请在开始操作前拔掉产品的电源线，或者在产品必须使用电源来执行任务时，小心从事。

Preface

This manual contains maintenance procedures for service personnel. It is divided into the following chapters:

1. **General information** contains a general description of the printer and the maintenance approach used to repair it. Special tools and test equipment, as well as general environmental and safety instructions, are discussed.
2. **Diagnostic information** contains an error indicator table, symptom tables, and service checks used to isolate failing field replaceable units (FRUs).
3. **Diagnostic aids** contains tests and checks used to locate or repeat symptoms of printer problems.
4. **Repair information** provides instructions for making printer adjustments and removing and installing FRUs.
5. **Connector locations** uses illustrations to identify the connector locations and test points on the printer.
6. **Preventive maintenance** contains the lubrication specifications and recommendations to prevent problems.
7. **Parts catalog** contains illustrations and part numbers for individual FRUs.

Conventions

Note: A note provides additional information.

Warning: A warning identifies something that might damage the product hardware or software.

There are several types of caution statements:

	<p>CAUTION</p> <p>A caution identifies something that might cause a servicer harm.</p>
---	---

	<p>CAUTION</p> <p>This type of caution indicates there is a danger from hazardous voltage in the area of the product where you are working. Unplug the product before you begin, or use caution if the product must receive power in order to perform the task.</p>
---	--

	<p>CAUTION</p> <p>This type of caution indicates a hot surface.</p>
---	--

	<p>CAUTION</p> <p>This type of caution indicates a tipping hazard.</p>
---	---

1. General information

The Lexmark™ E260d and E260dn are monochrome laser printers designed for single users or small workgroups. This book contains information on E260d and E260dn. For information on E360d and E360dn, see the 4513-420,-430 service manual. For information on E460dn and E460dw, see the 4513-630, -63W, -6EW service manual.

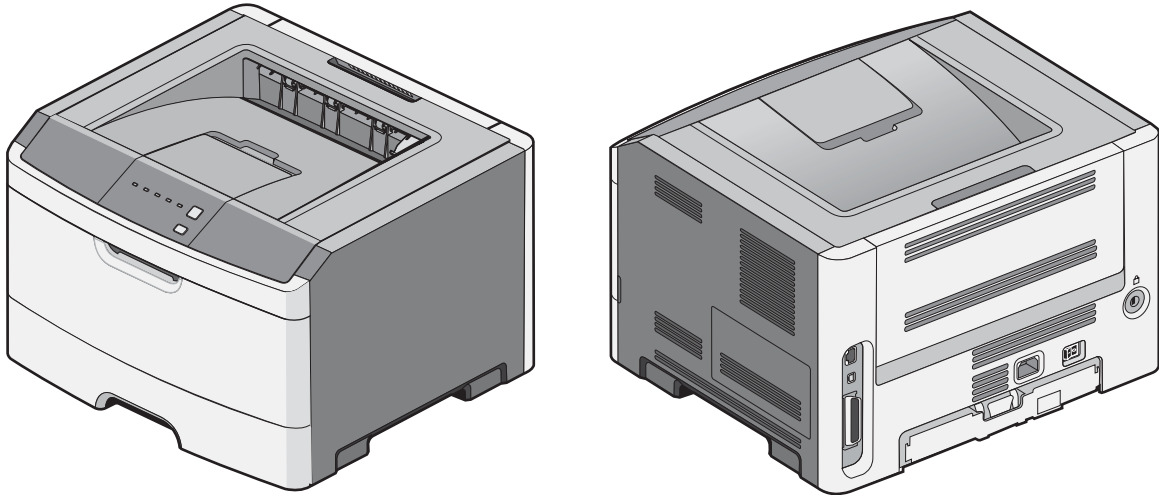







Maintenance approach

The diagnostic information in this manual leads to the correct field replaceable unit (FRU) or part. Use the error code charts, symptom index, and service checks to determine the symptom and repair the failure. See **“Diagnostics information” on page 2-1** for more information. See **“Repair information” on page 4-1** to help identify parts. After completing the repair, perform tests as needed to verify the repair.

Overview of the operator panel

The operator panel consists of these items:

- LED operator panel
- Two buttons: Cancel and Continue
- Six lights: Error , Paper Jam , Load Paper , Toner Low / , Ready , and Continue 

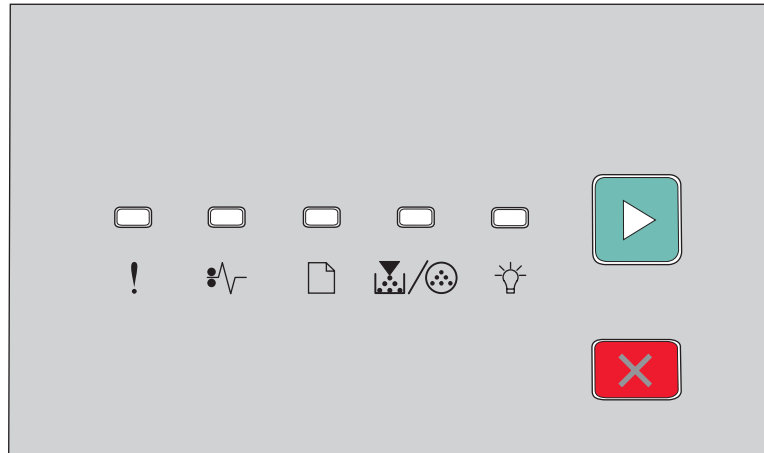

Specifications

Memory

Item	4513-220 Lexmark E260d	4513-230 Lexmark E260dn
Standard memory	32MB	32MB
Maximum memory	160MB	160MB
Optional memory		
128MB	✓	✓
256MB	x	x
512MB	x	x
Optional flash memory		
64MB	x	x
256MB	x	x
Optional font cards (DBCS)	✓	✓
Option slots		
Memory slots	1	1
Flash memory/option card	x	x

Print quality settings

Item	4513-220 Lexmark E260d	4513-230 Lexmark E260dn
Print resolution		
1200 Image quality ¹	✓	✓
2400 Image quality ²	✓	✓
600 X 600 dpi	✓	✓
1200 X 1200 dpi ³	✓	✓
¹ 1200 Image quality is defined as 600 dpi with 2 bit IET (Image Technology) default mode for all models.		
² 2400 Image quality is defined as 600 dpi with 4 bit IET.		
³ True 1200 dpi at 1/2 the rated speed		

Connectivity and compatibility

Item	4513-220 Lexmark E260d	4513-230 Lexmark E260dn
Data stream emulations		
Host based printing	✓	✓
PCL 5e and PCL 6	✓	✓
PostScript 3	✓	✓
PPDS migration tool	✓	✓
PDF v1.6	x	x
XPS ¹	x	x
HTML (including DBCS)	x	x
Directimage	x	x
Compatibility	Windows/Macintosh/Linux	Windows/Macintosh/Linux
Standard local connections		
Parallel	✓	✓
USB*	✓	✓
Standard network connections		
Ethernet (10/100 Base Tx)	x	✓
Wireless ethernet 802.11b/g/n	x	x
Optional local connections		
Optional network connections: external print server support	✓	✓
*All models are USB 2.0 Certified devices supporting Hi-Speed data transfer.		
¹ Includes the HD photo image format		
² Includes support for the following graphics formats: TIFF, TIF, JPG, GIF, PNG, BMP, PCX, AND DCX		

Media trays and supply capacity

Item	4513-220 Lexmark E260d	4513-230 Lexmark E260dn
Available input trays		
Integrated 250-sheet tray	✓	✓
50-sheet MP feeder	x	x
1-sheet manual feed slot	✓	✓
Optional input sources		
250-sheet drawer	✓	✓
550-sheet drawer	✓	✓
Manual/integrated print duplex	Integrated	Integrated
Envelope conditioning	x	x
Available output trays		
Standard 150-sheet sensing bin	✓	✓
Toner and photoconductor		
Toner cartridge	1,000 standard pages SWE ¹ 3,500 standard pages	1,000 standard pages SWE ¹ 3,500 standard pages
High toner cartridge	x	x
Photoconductor kit	Up to 30,000 ²	Up to 30,000 ²
¹ Declared value in accordance with ISO/IEC 19752		
² Up to 30,000 pages, based on an average of 3 pages per job and approximately 5% coverage per page. Yields may vary based on customer usage.		

Types of print media

Note: Ensure trays are properly loaded. Never mix media types within a tray.

Source	Sizes	Types	Weight	Input capacity* (sheets)
Input tray 1 (250-sheet tray)	A4, A5, A6, JIS ¹ -B5, letter, legal, executive, oficio (Mexico) ² , folio ² , statement	Plain paper, recycled, labels, bond, letterhead, preprinted, colored paper, light paper, heavy paper, rough/cotton, custom type [x]	60–90 g/m ² (16–24 lb)	<ul style="list-style-type: none"> • 250 paper • 50 labels**
2nd Drawer option (250/550-sheet drawer)	A4, A5, JIS ¹ -B5, letter, legal, executive, oficio (Mexico) ² , folio ² , statement	Plain paper, recycled, labels, bond, letterhead, preprinted, colored paper, light paper, heavy paper, rough/cotton, custom type [x]	60–90 g/m ² (16–24 lb)	<ul style="list-style-type: none"> • 250 paper • 550 paper • 50 labels**
Manual feed input	A4, A5, A6, JIS ¹ -B5, letter, legal, executive, folio, oficio, statement, Universal	Plain paper, transparency, bond, letterhead, preprinted, colored paper, light paper, heavy paper, rough/cotton, custom type [x]	60–163 g/m ² (16–43 lb)	1 (all medias)
		Card stock***	<ul style="list-style-type: none"> • 120–163 g/m² (16–43 lb) Index Bristol • 75–163 g/m² (46–100 lb) Tag 	1
	7 ¾, 9, 10, DL, C5, B5, other	Envelopes Rough envelopes	75 g/m ² (20 lb)	1
Duplex	A4, letter, legal, oficio (Mexico) ² , folio ²	Plain paper, recycled, bond, letterhead, preprinted, colored paper, light paper, heavy paper, custom type [x]	60–90 g/m ² (16–24 lb)	
<p>* Capacity for 20 lb print media, unless otherwise noted. ** Use for occasional printing only. *** Grain short is recommended. Use rear exit for best results. ¹Japanese Industry Standard ² If a source supports size sensing and is activated, then neither the “oficio” value nor the “folio” value appears in that source’s list of supported media sizes. These values only appear in a source’s list of supported media sizes either when the source is non-size sensing or when the source’s size sensing hardware is deactivated and then the device is power cycled.</p>				

Tips on preventing jams

Paper path

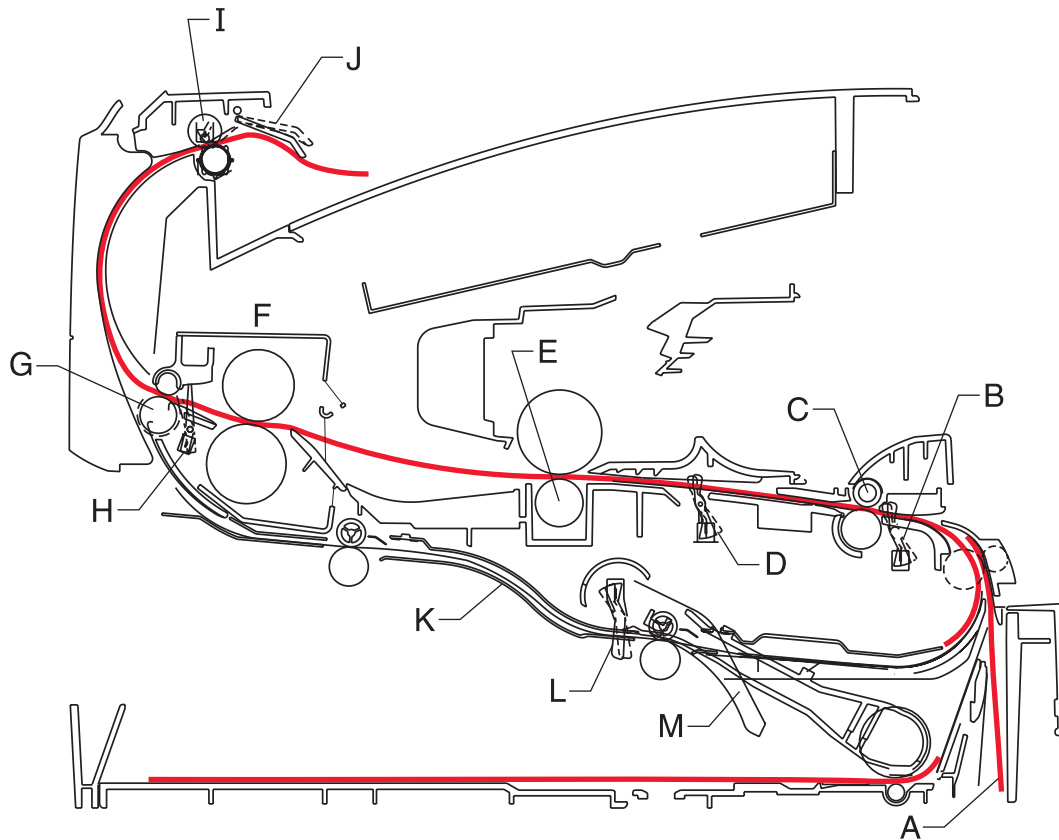

A	Paper path	A-B	125.3
B	Manual feed sensor	B-C	9.0
C	Upper end feed rolls	C-D	59.8
D	Input sensor	D-E	44.9
E	Transfer roll	E-F	112.7
F	Fuser	F-G	21.4
G	Fuser exit rolls	G-H	114.8
H	Fuser exit sensor	H-I	7.5
I	Exit rolls	I-J	17.0
J	Exit sensor	I-K	211.7
K	Duplex unit	K-L	93.4
L	Duplex sensor	L-M	8.4
M	Auto compensator	M-B	177.2

Most paper jams can be avoided by correctly loading paper and specialty media in the printer.

The following hints can help prevent paper jams:

- Use only the recommended print media.
- Do not overload the print media sources. Make sure the stack height does not exceed the maximum height indicated by the stack line on the labels in the sources.
- Do not load wrinkled, creased, damp, or curled print media.
- Flex, fan, and straighten print media before loading it. If jams do occur with the print media, then try feeding one sheet at a time through the manual feeder.

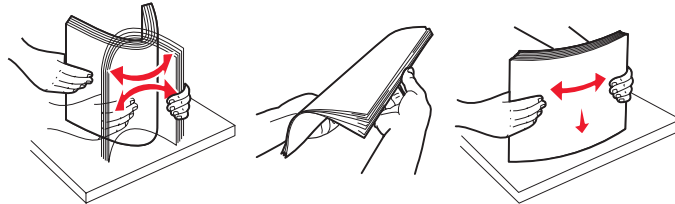

- Do not mix print media sizes, weights, or types in the same print media source.
- Push all trays in firmly after loading them.

Note: Make sure the media stack is below the maximum media fill indicators on the 250-sheet tray before pushing the tray into the printer.

- Make sure paper guides are positioned before loading the paper or specialty media.
- Do not remove trays while a job is printing.
- Before loading transparencies, fan the stack to prevent sheets from sticking together.
- Do not use envelopes that:
 - Have excessive curl
 - Are stuck together
 - Are damaged in any way
 - Contain windows, holes, perforations, cutouts, or embossments
 - Have metal clasps, string ties, or metal folding bars
 - Have postage stamps attached
 - Have any exposed adhesive when the flap is in the sealed position
- Use only recommended media. Refer to the *Card Stock & Label Guide* available on the Lexmark Web site at www.lexmark.com for more information about which media provides optimum results for the current printing environment.

Tools

The removal and adjustment procedures require the following tools and equipment:

- Spring hook
- Needle nose pliers
- Volt-ohmmeter
- #1 and #2 Phillips screwdriver
- Slotted screwdriver

Acronyms

ACM	Autocompensator Mechanism (or paper feed)
ADC	Analog-to-digital Converter
ASIC	Application Specific Integrated Circuit
CBM	Complete Bill Of Material
DEV	Development Roll (of print cartridge/photoconductor system)
DIMM	Dual In-Line Memory Module
ENA	External Network Adapter
FRU	Field Replaceable Unit
HBP	Host Based Printing
HVPS	High Voltage Power Supply
LCD	Liquid Crystal Diode
LED	Light Emitting Diode
LSU	Laser Scanning Unit
LVPS	Low Voltage Power Supply
NVRAM	Nonvolatile Random Access Memory
PC	Photoconductor
PCL	Printer Control Language
POR	Power-On Reset
POST	Power-On Self Test
PPDS	Personal Printer Data Stream
PRC	People's Republic of China
TAR	Toner Add Roll
SDR	Synchronous Dynamic RAM
SWE	Shipped With Equipment
USB	Universal Serial Bus
V ac	Volts alternating current
V dc	Volts direct current

2. Diagnostics information

Start



CAUTION: Unplug power from the printer before connecting or disconnecting any other cable, assembly, or electronic card. This is a precaution for personal safety and to prevent damage to the printer.

This chapter contains the codes and diagnostic tools to aid in providing corrective action for a malfunctioning printer. To determine the corrective action to repair a printer, look for the following information:

- A description of a problem, see **“Diagram of the printer menus” on page 2-43.**
- Information from the operator panel of the printer.
 - **Models E260d and E260dn** have an operator panel containing lights and buttons.

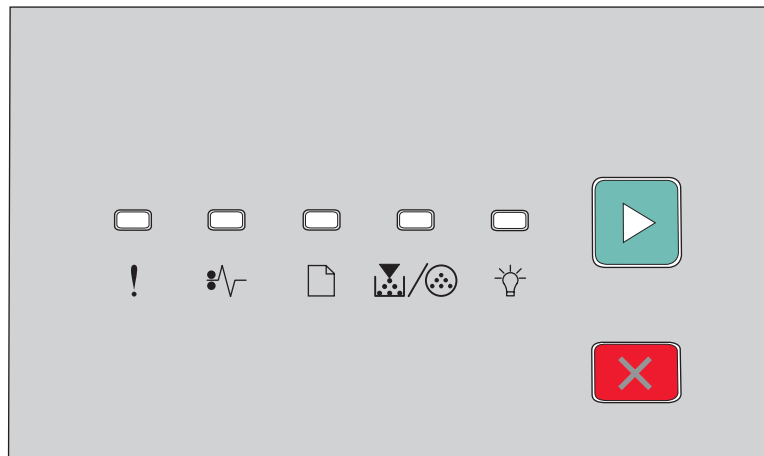

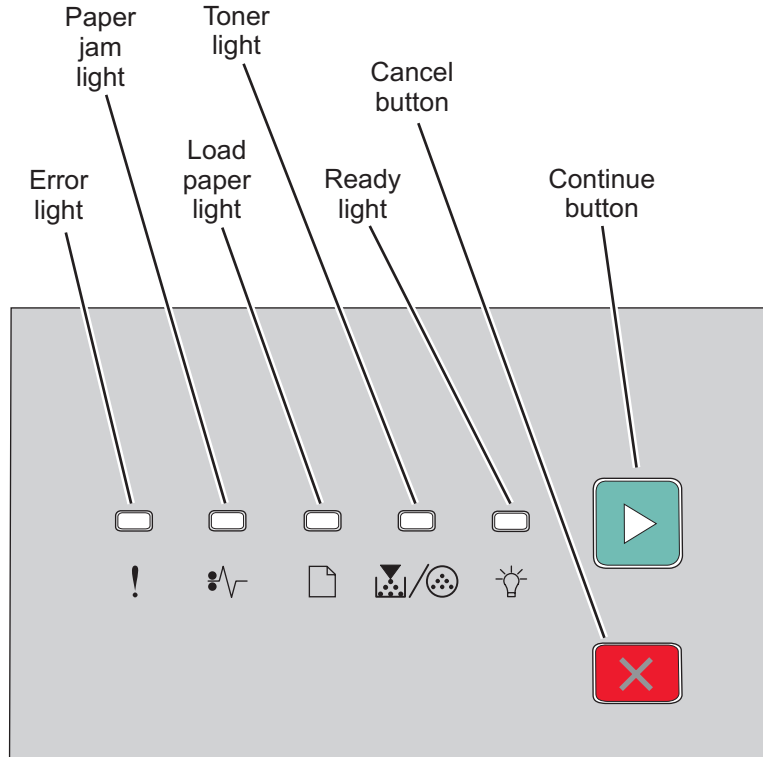

Warning: Paper clips are commonly used near printers and can become lodged in the paper path. Always check for and remove any debris in the paper path.

Overview of the operator panel





Power-On Self Test (POST) sequence

When the printer is turned on, it performs a POST. Check for correct POST functioning of the base printer by observing the following process:

1. All operator panel lights on momentarily
2. Lights then flash on and off sequentially.
3. After the lights quit flashing, the  light flashes until the fuser comes up to temperature (5-20 additional seconds, depending on the initial temperature of the fuser) and then stays on.
4. If there is a problem in the printer such as a paper jam, then the panel lights indicate the problem. See **“Common primary light patterns” on page 2-4** for more information.
5. The printer cycles down into standby mode, and  lights solid.

Light patterns and error messages

User attendance messages, paper jam errors, and service errors display a light pattern. This may be all the information that is needed. However, if  is double-clicked on the panel, a second pattern may appear with more detailed information. If  is double-clicked again, the first pattern usually returns. Not all initial level light patterns have secondary patterns. In which case, when double-clicking, the pattern does not change.

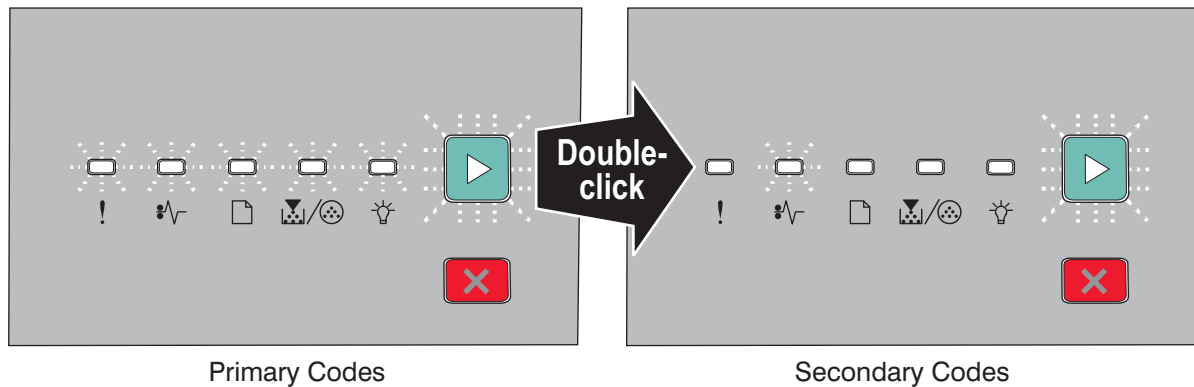

All service errors are indicated by all lights flashing as the primary notification or code. The secondary code indicates an area or function which has the error. Additional tertiary codes used for service (see **“Service tertiary error codes”** on page 2-30) indicate specific errors. See **“Service codes”** on page 2-28.







Note: If data is sent to the printer and all lights flash immediately, and double-clicking does not change the display, then there may be a code problem. Contact the next level of support.







Common primary light patterns

See **“Overview of the operator panel” on page 2-2** for icon information.







●	Light on
	Light off
*	Light blinking
x	Light blinking slowly

Common light sequences







Printer Condition	Page						
Ready/Power Saver	7					●	
Demo Mode Ready	7					●	*
Busy <ul style="list-style-type: none"> • Defragmenting Flash • Formatting Flash • Printing Directory • Printing Font List • Printing Menu Settings • Printing the Print Quality Test Page • Programming Flash 	8					*	
Hex Trace Ready	8					x	
Waiting	8					●	●
Flushing buffer/Resolution reduced	9	*				*	
Not ready (printer is offline)	9						●
Close door or Insert Cartridge	10	●					
Unsupported Flash Option Installed	10	●					
Cancel job	10	●	●	●	●	●	●
Reset printer	10	●	●	●	●	●	●
Restore factory defaults	10	●	●	●	●	●	●
Invalid engine code	11	●				●	
Invalid network code	11	●				●	
Resolution reduced while canceling job	11	*	●	●	●	*	●
Toner cartridge region mismatch	12	●			●		
Change cartridge invalid refill	12	●			●		
Missing or defective print cartridge	12	●			●		
Unsupported print cartridge	12	●			●		
Photoconductor kit life warning ¹	12				*		●
Programming engine code/ Programming system code	13			●	●	●	
Service error ²	13	*	*	*	*	*	*
Printer error ³	13	●					●

Printer Condition	Page						
Paper jam printer error (2xx)	14		●				●
Remove paper from output bin	14			*			
Load media in Tray 1 or Tray 2	14			●			●
Load Media in Multi-purpose Feeder or Manual Feeder	15			●			
Load Tray 1 for side 2 of manual duplex printing	15			●			*
¹ Toner low light will remain flashing with other primary light sequences. ² Secondary codes, and often a tertiary code, will follow this code. ³ Secondary codes will follow this code.							

Common light sequences when the toner is low







Printer Condition	Page						
Toner low¹	11				●		●
Ready and Toner Low/Power Saver and Toner Low					●		●
Demo Mode Ready and Toner Low					●	●	*
Hex Trace Ready and Toner Low					●	x	
Busy and Toner Lower <ul style="list-style-type: none"> Defragmenting Flash and Toner Low Formatting Flash and Toner Low Printing Directory and Toner Low Printing Font List and Toner Low Printing Menu Settings and Toner Low Printing Print Quality Test pages and Toner Low Programming Flash and Toner Low 					●	*	
Resolution reduced/Flusher buffer and Toner Low		*			●	*	
Waiting and Toner Low					●	●	●
Not Ready and Toner Low					●		●
Replace Photoconductor and Toner Low					●		
¹ Toner low light will remain on with other primary light sequences.							

Common light sequences when replacing the photoconductor







Printer Condition	Page						
Replace photoconductor (printer hard stop)	12	*			*		●
Ready and Replace Photoconductor/Power Save and Replace Photoconductor					*	●	
Demo Mode Ready and Replace Photoconductor					*	●	*
Hex Trace Ready and Replace Photoconductor					*	x	
Busy and Replace Photoconductor <ul style="list-style-type: none"> • Defragmenting Flash and Replace Photoconductor • Formatting Flash and Replace Photoconductor • Printing Directory and Replace Photoconductor • Printing Font List and Replace Photoconductor • Printing Menu Settings and Replace Photoconductor • Printing Print Quality Test pages and Replace Photoconductor • Programming Flash and Replace Photoconductor 					*	*	
Resolution reduced/Flushing buffer and Replace Photoconductor		*			*	*	
Device is printing and Replace Photoconductor					*	*	*
Waiting and Replace Photoconductor					*	●	●
Not Ready and Replace Photoconductor					*		●
Replace Photoconductor IR		*			*		●

Primary codes







Ready/Power Saver

					
				●	
Meaning <ul style="list-style-type: none"> The printer is ready to receive and process data. The printer is in Power Saver mode. 					
Action <ul style="list-style-type: none"> Send a print job. Press Continue ▷ to print the menu settings pages for a list of current printer settings. Press and hold Cancel ✕ to reset the printer. 					







Demo Mode Ready

					
				●	*
Meaning <ul style="list-style-type: none"> The printer is in the Ready state and the Demo Mode is active. The printer is ready to receive and process data from a host system. 					
Action <p>Press Continue ▷ briefly to print the next Demo page.</p>					







Busy

					
				*	
Meaning					
<ul style="list-style-type: none"> The printer is busy receiving and processing data or printing. The printer is printing a directory, font list, menu settings pages, or Print Quality Test Pages. The printer is defragmenting, formatting, or programming Flash. 					
Action					
<p>Busy:</p> <ul style="list-style-type: none"> Wait for the message to clear. Press and release Cancel X to cancel the print job. Press and hold Cancel X to reset the printer. <p>Printing a directory, a font list, menu settings pages, or Print Quality Test Pages:</p> <ul style="list-style-type: none"> Wait for the pages to print. The Ready light flashes as the pages print. The Ready light is on when the printing stops. Press and release Cancel X to cancel printing. Press and hold Cancel X to reset the printer. 					







Hex Trace Ready

					
				x	
Meaning					
The printer is in the Ready mode, and Hex Trace is active.					
Action					
<ul style="list-style-type: none"> Advanced users can use Hex Trace to help troubleshoot printing problems. After resolving the problem, turn off the printer to exit Hex Trace. Wait for the message to clear. Press and hold Cancel X to reset the printer. 					







Waiting

					
				●	●
Meaning					
The printer is waiting until a print timeout occurs, or until it receives additional data.					
Action					
<ul style="list-style-type: none"> Press Continue ▷ to print the contents of the print buffer. Press and release Cancel X to cancel the print job. Press and hold Cancel X to reset the printer. 					

Flushing buffer/Resolution reduced

					
*				*	
Meaning					
<ul style="list-style-type: none"> The printer is flushing corrupted print data. The printer is processing data or printing pages, but the resolution of a page in the current print job is reduced from 600 dots per inch (dpi) to 300 dpi to prevent a memory full error. 					
Action					
<ul style="list-style-type: none"> Wait until the control panel returns to Ready to print other jobs. Press and release Cancel X to cancel the print job. Press and hold Cancel X to reset the printer. 					

Not ready (printer is offline)

					
					●
Meaning					
The printer is not ready to receive or process data, or the printer ports are offline.					
Action					
<ul style="list-style-type: none"> Press and release Continue ▷ to return to the Ready state. Press and release Cancel X to return to the Ready state. 					

Close door or insert cartridge/Unsupported Flash option installed

●					
Meaning					
The printer front door is open, print cartridge is missing, or a flash option has been installed that is not supported.					
Action					
Close the door, install a print cartridge, or install a supported flash option. The printer will automatically reset.					







Insufficient collation area/Insufficient memory

●					●
Meaning					
The printer memory is too full to collate the print job.					
Action					
<ul style="list-style-type: none"> • Press and release Continue ▷ to clear the message and continue printing the job. (The job may not print correctly.) • Press and release Cancel ✕ to cancel the print job. • Press Cancel ✕ to reset the printer. 					







Cancel job/Reset printer/Restore factory defaults

●	●	●	●	●	●
Meaning					
<ul style="list-style-type: none"> • The current print job is canceled. • The printer is resetting to the user default settings. Any active print jobs are canceled. A user default setting remains in effect until it is changed or has restored the factory default settings. 					
Action					
Wait for the message to clear.					







Invalid engine code/Invalid network code

					
●				●	
Meaning					
The engine code and/or the network code has not been programmed or has been programmed but is invalid.					
Action					
Download valid engine code to the internal print server.					







Resolution reduced while canceling job

					
*	●	●	●	*	●
Meaning					
The printer is processing data and/or printing and the resolution of the page belonging to the currently printing job has been reduced from 600 dpi to 300 dpi in order to prevent a Memory Full error.					
Action					
Pressing Cancel X will cancel the print job. Other buttons are ignored.					







Toner low

					
			●		●
Meaning					
The printer is ready to receive and process data. In addition, the toner in the toner cartridge is getting low.					
Action					
<ul style="list-style-type: none"> • Press and release Continue ▷ to clean the light sequence and continue processing the print job. • Turn the printer off. • Remove the toner cartridge, and shake it to extend the life. • Replace the toner cartridge. 					







Toner cartridge region mismatch/Change cartridge invalid refill/Missing or defective print cartridge/Unsupported print cartridge

					
●			●		
Meaning					
The geographic region of the printer does not match the geographic region of the installed toner cartridge.					
Action					
Remove the toner cartridge, and install a new toner cartridge that matches the region of the printer.					







Photoconductor kit life warning

					
			*		●
Meaning					
The photoconductor is almost full and should be replaced soon.					
Note: The Toner Alarm must be turned on in the driver for this message to appear. The factory default is Off .					
Action					
<ul style="list-style-type: none"> • Press and release Continue ▷ to clear the light sequence and continue printing. • Replace the photoconductor kit. 					







Replace photoconductor (printer hard stop)

					
*			*		●
Meaning					
The photoconductor kit is full and must be replaced. The printer will not print any more pages until the photoconductor kit is replaced.					
Action					
<ul style="list-style-type: none"> • Press and release Continue ▷ to print a photoconductor kit instruction page. • Replace the photoconductor kit. 					







Programming engine code/Programming system code

					
		●	●	●	
Meaning					
New code is being programmed into the engine or firmware code flash.					
Action					
Wait for the message to clear. When the printer has finished programming the code, it performs a soft reset.					







Service error

					
*	*	*	*	*	*
Meaning					
The printer has a service error, and printing has stopped.					
Action					
Press Continue ▷ twice to see the secondary code. See “Service codes” on page 2-28 to locate the problem.					







Printer error

					
●					●
Meaning					
The printer has one of the following errors:					
<ul style="list-style-type: none"> • Memory is full, insufficient to save what is in the buffer. • A page is too complex to print or is shorter than the set page margins. • Resolution of a formatted page is reduced to 300 dpi. • A font error occurred. • Communication with the host computer is lost. • Short media. 					
Action					
<ul style="list-style-type: none"> • Press Continue ▷ twice quickly to see the secondary error code. • Press Continue ▷ to clear the secondary message. 					







Paper jam printer error (2xx)

					
	●				●
Meaning					
The printer has a paper jam.					
Action					
<ul style="list-style-type: none"> • Press Continue ▷ twice quickly to see the secondary error code. • Press Continue ▷ to resume printing once all the jammed pages are cleared from the paper path. 					







Remove paper from output bin

					
		*			
Meaning					
The output bin is full.					
Action					
<ul style="list-style-type: none"> • Remove printed pages from the output bin. • Press Continue ▷ to clear the error code. 					







Load media in Tray 1 or Tray 2

					
		●			●
Meaning					
The printer is out of print media at the indicated source.					
Action					
<ul style="list-style-type: none"> • Load print media into the indicated tray, and press Continue ▷ to resume printing. • Press Cancel × to reset the printer. 					

Load media in multi-purpose feeder or manual feeder

					
		●			
Meaning					
The printer prompts to load a single sheet of print media in the multi-purpose feeder or manual feeder.					
Action					
<ul style="list-style-type: none"> • Load print media into the manual feeder. • Press Continue ▷ to resume printing. • Press Cancel ✕ to reset the printer. 					

Load media Tray 1 for Side 2 of manual duplex printing

					
		●			*
Meaning					
The printer prompts to load side 2 of a single sheet of print media in Tray 1 for duplex printing.					
Action					
<ul style="list-style-type: none"> • Load side 2 of a single sheet of print media in Tray 1. • Press Continue ▷ to resume printing. • Press Cancel ✕ to reset the printer. 					

Common secondary light patterns



Press and release **Continue** ▷ twice quickly to display the secondary error code light sequence. The following table shows what these light sequences mean and where to go for help.

Common light sequences for paper jams







When the **Paper jam** ⚠ and **Continue** ▷ lights are both on, a paper jam has occurred with a secondary error code.

Printer Condition	Page	⚠	⚡	📄	🗑️/🗑️	💡	▷
200: Paper jam at the input sensor	18		●			●	●
201: Paper jam between the input and exit sensor	18		●		●		●
202: Paper jams at the exit sensor	18		●	●			●
231: Paper jam (duplex rear)	18		●	*			●
232: Paper jam (duplex front)	19		●		*		●
233: Paper jam (duplex)	19		●	*	*		●
234: Paper jam (duplex: location unknown)	19		●			*	●
241: Paper jam in Tray 1	19		●	●	●		●
242: Paper jam in Tray 2	19		●	●		●	●
251: Paper jam in the manual feeder	20		●		●	●	●

Common light sequences for printer errors







When the **Error**  and **Continue**  lights are both on, a printer error has occurred with a secondary code.

Press and release **Continue**  twice quickly to display the secondary error code light sequence. The following table shows what these light sequences mean and where to go for help.







Printer Condition	Page						
Complex page	20	●				●	●
Insufficient collation area	21	●			●		●
Defective flash	21	●		●			●
Network interface errors	21	●	●				●
Resource save off-deficient memory	22	●				*	●
PPDS font error	22	●			*		●
Invalid configuration	23	●	*	*	*	*	●
Insufficient defrag memory	22	●		*			●
ENA connection lost	23	●	*				●
Host interface disabled	23	●	*	*			●
Memory full	23	●			●	●	●
Short media	24	●		●		●	●
Flash full	24	●	●			●	●
Invalid engine code	24	●		●		●	
Invalid network code	25	●		*		●	
Toner cartridge region mismatch	25	●		*	●		
Change toner cartridge / invalid refill	25	●	*		●		
Missing / Defective toner cartridge	26	●	●		●		
Unsupported toner cartridge	26	●		●	●		
Too many options attached	26	●		●	●		●
Unsupported Flash in slot 1	27	●	●	●	●		●
Unformatted Flash	27	●	●		●		●
Install MICR cartridge	27	●			*		*
MICR cartridge empty	27	*			●		

Secondary error codes







200: Paper jam at the input sensor

					
	●			●	●
Meaning					
A paper jam has occurred at the input sensor, which can be either after the print media leaves the tray and enters the printer or in the manual feeder.					
Action					
Open the front door, remove the print cartridge, and clear the paper jam.					







201: Paper jams between the input and exit sensors

					
	●		●		●
Meaning					
A paper jam has occurred. The jammed media is most likely in the fuser area under the toner cartridge assembly.					
Action					
Open the front door, remove the print cartridge, and clear the paper jam.					







202: Paper jams as a printed job exits the printer

					
	●	●			●
Meaning					
A paper jam has occurred as the print media is exiting the printer.					
Action					
Open the rear door, and clear the paper jam.					







231: Paper jam (duplex rear)

					
	●	*			●
Meaning					
The media did not arrive at the duplex sensor, but did leave the printer exit sensor.					
Action					
Open the rear door, and clear the paper jam.					







233: Paper jam (duplex)

					
	●	*	*		●
Meaning					
A paper jam has occurred in the duplex unit before					
Action					
Remove the tray, open the duplex door and clear the paper jam.					







234: Paper jam (duplex - unknown location)

					
	●			*	●
Meaning					
A paper jam has occurred somewhere around the duplex unit before making the manual input sensor.					
Action					
Remove the tray, open the duplex door and clear the paper jam. Paper may also be accessible inside the rear door.					







241: Paper jam in Tray 1

					
	●	●	●		●
Meaning					
A paper jam has occurred in Tray 1.					
Action					
Clear the paper jam after removing Tray or and/or Tray 2.					







242: Paper jam in Tray 2 (250-sheet pr 550-sheet option)

					
	●	●		●	●
Meaning					
A paper jam has occurred in Tray 2.					
Action					
Clear the paper jam after removing Tray 1 and/or Tray 2.					

251: Paper jam in the manual feeder

					
		●	●	●	●
Meaning					
A paper jam has occurred at the manual feeder.					
Action					
Clear the paper jam.					

Complex page

					
		●		●	●
Meaning					
The page may not print correctly because the print information on the page is too complex (that is, too large for the printer memory).					
Action					
<ul style="list-style-type: none"> • Press Continue ▷ to clear the error code and continue processing the print job (some of the print data may be lost). <p>To avoid this error in the future:</p> <ul style="list-style-type: none"> • Reduce the complexity of the page by reducing the amount of text or graphics on the page and deleting unnecessary download fonts or macros. • Set Page Protect to On in the Local Printer Setup Utility. • Install additional printer memory. 					

Insufficient collation area

●			●		●
Meaning					
The printer memory does not have the free space necessary to collate the print job. This may happen due to one of these errors:					
<ul style="list-style-type: none"> • Memory is full. • A page is too complex to print. • A page is shorter than the set page margins. • Memory is insufficient to save what is in the buffer. 					
Action					
<ul style="list-style-type: none"> • Press Continue ▷ to clear the message and continue printing the job. (The job may not print correctly.) • Press and release Cancel ✕ to cancel the print job. • Press and hold Cancel ✕ to reset the printer. <p>To avoid this error in the future:</p> <ul style="list-style-type: none"> • Simplify the print job. Reduce the complexity of the page by reducing the amount of text or graphics on the page and deleting unnecessary downloaded fonts or macros. • Install additional printer memory. 					







Defective Flash

●		●			●
Meaning					
The printer detects a defective flash.					
Action					
Press Continue ▷ briefly and the normal operation will continue. The flash will be marked as bad and cannot be used until the problem is resolved.					







Network interface errors

●	●				●
Meaning					
The printer cannot establish communication with the network.					
Action					
Press Continue ▷ to clear the message and continue printing. (The previous print job may not print correctly.)					







Resource save off - deficient memory

					
●	●				●
Meaning					
This error message indicates that too much memory has been allocated to link buffers or that some printer settings are using more memory than the default setting.					
Action					
Add more memory, change link buffers or reset the printer settings that have been changed.					







PPDS Font error

					
●		*			●
Meaning					
The printer does not have enough memory to save the data in the buffer.					
Action					
<ul style="list-style-type: none"> • Install additional memory. • Press Continue ▷ to continue printing the job. • Press Cancel ✕ to cancel the print job. 					







Insufficient defrag memory

					
●		*			●
Meaning					
The printer memory does not have the free space necessary to collate the print job. This may happen due to one of these errors:					
<ul style="list-style-type: none"> • Memory is full. • A page is too complex to print. • A page is shorter than the set page margins. • Memory is insufficient to save what is in the buffer. 					
Action					
<ul style="list-style-type: none"> • Press Continue ▷ to clear the message and continue printing the job. (The job may not print correctly.) • Press and release Cancel ✕ to cancel the print job. • Press and hold Cancel ✕ to reset the printer. <p>To avoid this error in the future:</p> <ul style="list-style-type: none"> • Simplify the print job. Reduce the complexity of the page by reducing the amount of text or graphics on the page and deleting unnecessary downloaded fonts or macros. • Install additional printer memory. 					







ENA connection lost

					
●	*				●
Meaning					
The printer cannot establish communication with the network.					
Action					
Press Continue ▷ to clear the code and continue printing. (The previous print job may not print correctly.)					







Host interface disabled

					
●	*	*			●
Meaning					
The printer USB or parallel port has been disabled.					
Action					
Press Continue ▷ to clear the code. The printer discards any print jobs previously sent. Enable the USB or parallel port by selecting a value other than Disabled for the USB Buffer or Parallel Buffer item in the Local Printer Settings Utility.					







Memory full

					
●			●	●	●
Meaning					
The printer is processing data, but there is not enough memory available to continue the job.					
Action					
<ul style="list-style-type: none"> • Press Continue ▷ to clear the message and continue printing the job (the job may not print correctly). • Press and release Cancel ✕ to cancel the print job. • Press and hold Cancel ✕ to reset the printer. <p>To avoid this error in the future:</p> <ul style="list-style-type: none"> • Simplify the print job. Reduce the complexity of the page by reducing the amount of text or graphics on the page and deleting unnecessary downloaded fonts or macros. • Install additional printer memory. 					







Short media

					
●		●		●	●
Meaning					
The media length is too short to print the formulated data. This occurs when the printer does not know the print media size loaded in the tray.					
Action					
<ul style="list-style-type: none"> • Make sure the print media that is loaded is long enough. • Open the front door, clear the paper path and close the door to resume printing. • Press Continue ▷ to clear the code and continue printing the job. • Press Cancel × to cancel the print job. 					







Flash full

					
●	●			●	●
Meaning					
The printer signals that there is not enough free space in the flash memory mode to hold the resources that have been requested to be written to flash.					
Action					
<ul style="list-style-type: none"> • Press Cancel × to cancel the print job. • Press Continue ▷ to clear the message and continue processing the job. <p>All downloaded fonts and macros that are not written to flash will be deleted.</p>					







Invalid engine code

					
●		●		●	
Meaning					
The engine code has not been programmed, or the programmed code is not valid.					
Action					
Download the valid engine code to the internal print server while this message is still on the panel.					







Invalid network code

					
●		*		●	
Meaning					
The code either in the controller board or network card is invalid.					
Action					
Download the valid network code to the printer. It may be downloaded while this message is displayed.					







Toner cartridge region mismatch

					
●		*	●		
Meaning					
The geographic region of the printer does not match the geographic region of the installed toner cartridge.					
Action					
Remove the toner cartridge, and install a new toner cartridge that matches the region of the printer. The settings cannot be changed without calling Lexmark for a one-time change.					







Change toner cartridge/invalid refill

					
●	*		●		
Meaning					
The toner in the toner cartridge is getting low, or an invalid refill toner has been installed.					
Action					
<ul style="list-style-type: none"> • Press and release Continue ▷ to clear the light sequence and continue processing the print job. • Turn the printer off. • Remove the toner cartridge, and shake it to extend the life, or replace the toner cartridge with a valid toner cartridge. • Replace the toner cartridge. • Turn the printer on. 					







Missing/Defective toner cartridge

					
●	●		●		
Meaning					
The toner in the toner cartridge is getting low, or a defective toner cartridge has been detected.					
Action					
<ul style="list-style-type: none"> • Press and release Continue ▷ to clear the light sequence and continue processing the print job. • Turn the printer off. • Remove the toner cartridge, and shake it to extend the life, or replace the toner cartridge if it is defective. • Replace the toner cartridge. • Turn the printer on. 					







Unsupported toner cartridge

					
●		●	●		
Meaning					
The toner cartridge is not supported by the printer.					
Action					
<ul style="list-style-type: none"> • Press and release Continue ▷ to clear the light sequence and continue processing the print job. • Turn the printer off. • Remove the toner cartridge, and replace it with a supported toner cartridge. • Turn the printer on. 					







Too many options attached

					
●		●	●		●
Meaning					
This message indicates that too many flash options have been attached.					
Action					
Press Continue ▷ briefly to clear the message. The option will be ignored.					







Unsupported flash in slot 1

					
●	●	●	●		●
Meaning					
The printer detects that a flash memory module is installed in the DIMM dram slot. This error will occur at power on and must be resolved before printing may continue.					
Action					
Power off the printer, and remove the unsupported option.					







Unformatted flash

					
●	●		●		●
Meaning					
The printer detects an unformatted flash at power on.					
Action					
Press Continue ▷ briefly to clear the message. The flash is marked as bad, and normal operation will continue. Flash operations will not be allowed until flash is formatted.					

Install MICR cartridge

					
●			*		*
Meaning					
The printer has detected that it requires the installation of a MICR cartridge in order to complete a print job that it has received.					
Action					
Install a MICR cartridge, and then close the cover to clear this message.					

MICR cartridge empty

					
*			●		
Meaning					
The RIP software has detected that the device's installed MICR cartridge is empty.					
Action					
Install a new regular or MICR cartridge, and then close the cover to clear this message.					

Service codes

All service errors are indicated by all lights flashing as the primary notification or code. The secondary light pattern indicates an area or function which has the error. Tertiary codes (shown on the following pages) indicate specific device errors. When all lights flash, double-click ▷ to see the secondary code. Double-click ▷ again to see the tertiary code. Double-click ▷ a third time to return to the primary light pattern.

In the following example:

- The primary light pattern indicates a service error (all flashing). Double-click ▷ for more information.
- The secondary light pattern indicates a fuser, toner sensor, or fan error. Double-click ▷ for more information.
- The tertiary light pattern indicates the fan has stalled. Double-click ▷ again, and the original primary light pattern will appear.

Note:

- The printer cannot directly determine that a fan has failed, but can sense the higher temperature at the fuser or printhead.
- If data is sent to the printer and all lights flash simultaneously, and double-clicking ▷ does not produce a secondary code, then there may be a code problem. Contact the next level of support.

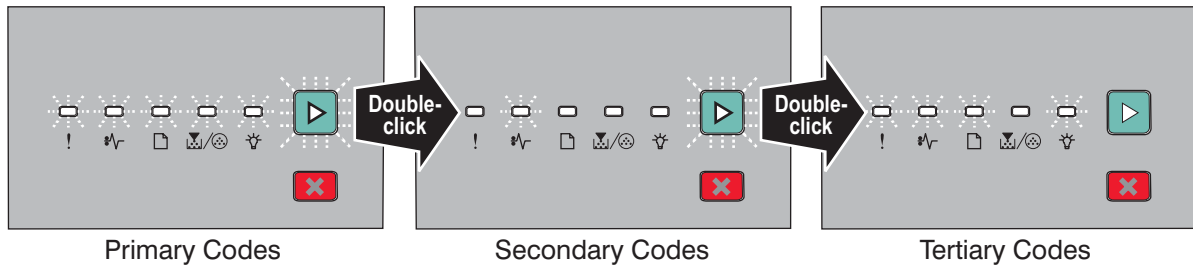

Service primary code

*	Light blinking
---	----------------







When this code appears, double-click ▷ to reveal the secondary codes.

Service primary code

Lights	!	⚡	📄	🔍/⚙️	💡	▷
Primary code for service errors See service secondary error codes	*	*	*	*	*	*

Service secondary error codes

Service secondary codes

						
Lights						
90x: Software						*
90x: Software	*		*		*	
91x: DC motor or transfer roll	*					*
92x: Fuser or toner sensor		*				*
93x: Printhead, drive motor	*	*				*
94x: LVPS service error			*			*
95x: Controller board (NCRAM, ROM, or NAND)	*		*			*
96: RAM memory		*	*			*
97x: Network	*	*	*			*
98x: Service paper port communication error				*		*
99x: Service device error	*			*		*
Programming error		*		*		*
40 and 41 Unsupported firmware card	*	*	*	*		*

Service tertiary error codes

Service tertiary error codes

Service error codes are generally non-recoverable except in an intermittent condition when POR (power-on reset) is performed which allows the printer to temporarily recover from the error. These error codes are recorded in the history file which can be reviewed through the Diagnostics Menu. See **“Diagnostics mode selections” on page 3-8.**

Note: All service errors are initially communicated by all lights flashing which is the primary indication or code. For brevity, this indication is not repeated in the following codes.



CAUTION: When this symbol appears, there is a danger from hazardous voltage in the area of the product that is being worked on. Unplug the product before beginning, or use caution if the product must receive power in order to perform the task.

Controller software

Codes 90x indicate a controller software error/illegal trap. For the other errors, which indicate a faulty programming process or faulty component on the controller board, replace the controller board. See **“Controller board removal” on page 4-6.**

Service tertiary error codes: controller software







Lights						
Service secondary codes: 90x						*
Service tertiary codes						
900: Service RIP software error					*	
901: Service engine flash error	*				*	
902: General engine software error		*			*	
903: Service engine software error	*	*			*	
904: Service engine software error			*		*	
905: Interface violation by paper port device	*		*		*	
906: Service engine software error		*	*		*	
Service watchdog: 90x	*		*		*	
901: Timer service slow		*		*		*

Transfer roll or tray 2

Code 914 indicates an error in tray 2 motor. Replace the drawer.

Code 917 indicates a problem in the transfer roll circuitry. Check the continuity from the cable connection on the HVPS (high voltage power supply) to the right side of the transfer roll.







Service tertiary error codes: transfer roll

						
Lights						
Service secondary codes: 91x	*					*
Service tertiary codes						
910: Service DC motor error					*	
911: Service DC motor error	*				*	
912: Service DC motor error		*			*	
913: Service DC motor error	*	*			*	
914: Tray 2 motor failure			*		*	
917: Transfer roll circuitry	*	*	*		*	

Fuser, fan, or toner sensor error

Codes 920 through 929 indicate a problem in the fuser, a stalled fan motor, or a faulty toner sensor or toner cartridge. Multiple errors indicate replacing the corresponding part.

Service tertiary error codes: fuser, fan, or toner sensor

						
Lights						
Service secondary codes: 92x		*				*
Service tertiary codes: fuser, fan, or toner sensor						
920: Fuser below temperature when printing					*	
921: Fuser below standby temperature at idle	*				*	
922: Fuser failed to reach standby temperature		*			*	
923: Fuser too hot during printing or idle	*	*			*	
924: Open circuit in thermistor path			*		*	
925: Incorrect fuser	*		*		*	
926: Service fuser error		*	*		*	
927: Fan stalled	*	*	*		*	
929: Toner sensor or toner cartridge are bad	*			*	*	







Printhead, transport motor, or RIP/engine communication error

Codes 930 through 935 indicate a problem with the printhead. Check cables to the printhead. Replace the printhead as necessary.

Codes 936 and 937 indicate a problem in the drive system motor.







Code 939 indicates a communication failure between the RIP and engine processors.

Service tertiary error codes: printhead, transport motor, or RIP engine communicator

						
Lights						
Service secondary codes: 93x	*	*				*
Service tertiary codes: printhead, transport motor, or RIP engine communicator						
930: Printhead error					*	
931: Printhead error	*				*	
932: Printhead error		*			*	
933: Printhead error	*	*			*	
934: Printhead error			*		*	
935: Printhead error	*		*		*	
936: Transport motor error		*	*		*	
937: Transport motor error	*	*	*		*	
939: Service RIP to engine communications failure	*			*	*	

RIP/engine communication or engine card error







Error code 940 indicates a communication failure between the RIP and engine processors. Error codes 947–949 indicate engine card failure.

						
Lights						
Service secondary codes: 94x						
Service tertiary codes: RIP engine communicator or engine card						
940: Service RIP to engine communications failure					*	
947: Service engine card failure	*	*	*		*	
948: Service engine card failure				*	*	
949: Service engine card failure	*			*	*	

NVRAM failure







Error codes 950–954 indicate a problem in the NVRAM (nonvolatile random access memory). Replace the operator panel assembly. Codes 955–959 indicate a failed controller board assembly. Replace the controller board.

Service tertiary error codes: NVRAM failure

Lights						
Service secondary codes: 95x	*		*			*
Service tertiary codes: NVRAM failure						
950: Secure EEPROM data does not match NVRAM					*	
951: Secure EEPROM failure	*				*	
952: NVRAM CRC failure		*			*	
954: NVRAM chip failure			*		*	
955: Code ROM or NAND failed CRC	*		*		*	
956: Processor failure		*	*		*	
957: ASIC failure	*	*	*		*	
958: NAND failure				*	*	
959: SRAM failure	*			*	*	

RAM memory error







Indicates an error in the RAM memory.

Lights						
Service secondary codes: 96x						
Service tertiary codes: RAM memory error						
960: Service RAM memory error					*	
961: Service RAM memory error	*				*	
962: Service RAM memory error		*			*	
963: Service RAM memory error	*	*			*	

Network error







Indicates an error in the network circuitry. Replace the controller board assembly.

Service tertiary error codes: network error

						
Lights						
Service secondary codes: 97x	*	*	*			*
Service tertiary codes: network error						
970: Service network error					*	
971: Service network error	*				*	
972: Service network error		*			*	
973: Service network error	*	*			*	
974: Service network error			*		*	
975: Unrecognizable network port	*		*		*	
976: Unrecoverable software error in network port		*	*		*	
977: Service network error	*	*	*		*	
978: Bad checksum while programming port				*	*	
979: Flash parts failed while programming port	*			*	*	







Paper port communication error

Indicates a communication error in the paper port.

						
Lights						
Service secondary codes: 98x						
Service tertiary codes: paper port communication error						
980: Service paper port communication failure					*	
981: Service paper port communication failure	*				*	
982: Service paper port communication failure		*			*	
983: Service paper port communication failure	*	*			*	
984: Service paper port communication failure			*		*	

Device equipment check or device controller board error

Indicates a failure with the device's equipment or controller board.

						
Lights						
Service secondary codes: 99x						
Service tertiary codes: device equipment check or device controller board error						
990: Service device equipment check					*	
991: Service device controller board failure	*				*	

Messages and error codes

Note: The following message and error codes will be visible only in the print event log in the diagnostic mode for E260d and E260dn. See “**Diagnostics mode selections**” on page 3-8.

The printer operator panel displays light patterns describing the current state of the printer and indicates possible printer problems that must be resolved. This topic provides a list of all printer messages and explains what they mean.

User attendance messages

Cartridge error codes

Error	Description
31.xx	Defective cartridge
32.xx	Unsupported cartridge
33.xx	Invalid refill

Paper jam error codes (200-series)

Repeating jams or jam messages can be caused by any of the following:

- Faulty/contaminated pick solenoids or worn cams of the solenoids.
- Faulty/contaminated flags or springs.
- Debris in the paper path.
- Media not of the specified length.

Paper jam error codes (200-series)

Error	Description
200.00	Paper jam around input sensor.
200.01	Classic input jam. The media is too long over the input sensor. Possible causes include multi-sheet feed, tray size sensing problem, and media slippage.
200.02	The main input sensor never became uncovered from the sheet ahead.
200.03	The video never started on the page at the input sensor within two inches after hitting the input sensor
200.04	The media at the input sensor before interrupt occurred—not enough time elapsed since the printhead started to expect the printhead mirror motor lock. Possible causes include bouncy sensor or exceptionally fast pick—perhaps due to media pre-staged in the source tray.
200.06	Imaged page not expected page (bouncy passthru sensor)
200.08	Media reached the input sensor before the EP was ready
200.09	Transfer servo never started
200.11	Mirror motor fell out of lock condition after paper at input sensor
200.12	Media detected at manual feeder sensor when not expected. Possible causes include user insert of media when motor is running or pre-staged media in the tray.
200.13	The input sensor is covered when the media is not expected (media in machine during warm-up)

Paper jam error codes (200-series) (Continued)

Error	Description
200.14	Trailing edge cleared manual feed, but did not successfully debounce the sensor. Potential causes are a small gap or a bouncy manual feed sensor.
200.15	UNRECOVERABLE NO GAP JAM. Engine detected no gap at the manual feeder sensor, attempted to open the gap by stopping the feed rolls, but no trailing edge was ever seen at the input sensor.
200.16	Transport motor error detected
200.17	Took too long to ramp up transport motor
200.18	Manual feeder sensor never became uncovered from the sheet ahead.
200.19	The media never reached the input sensor, but was detected at manual feeder sensor.
200.20	The media is too long over the manual feeder sensor. Possible causes include multi-sheet feed, media size (length) problem, pre-staged media in the tray.
200.22	FAILED SMALL GAP OR NO GAP JAM RECOVERY. Engine detected small gap or no gap at the manual feeder sensor, opened the gap by stopping the feed rolls, but never saw the leading edge of the second page at the input sensor.
200.23	Laser Servo never started due to potential conflict with the transfer servo. Possible causes: slow or missing transport motor positional feedback, or the media is transferred too quickly to the input sensor.
200.24	The measured gap at the input sensor is too small to meet the video delivery requirements. (There is not enough time since prior image finished to start new image)
200.26	The trailing edge never cleared the input sensor when feeding out the media that was detected during warm-up.
200.27	Printhead Driver: Mirror motor fell out of lock condition after the media at the input sensor—more time elapsed since the printhead than the expected stable lock time, but less than the printhead jitter-stable specification. Mirror motor fell out of lock condition after media at the input sensor—more time elapsed since the printhead than expected stable lock time, but less than the printhead jitter-stable specification.
200.28	First writing line of a page at the developer nip, but laser servo cleanup is not complete. Likely pre staged media or a fast paper feed.
200.29	Printhead drive control out of range due to an external event beyond what the control is designed to handle. Probable causes: ESD or noise on hsync signal.
200.30	Narrow media sensor covered during warm-up.
200.32	Media more than 14 inches too long over the manual feeder sensor. Possible causes include multi-sheet feed or pre-staged media in the tray.
200.33	Page from tray 1 did not reach the input sensor after multiple attempts. Page did make it out of the tray at least as far as the manual feeder sensor. Possible cause is that the page stalled at the alignment gate.
200.34	Timed out waiting for page from tray 1 to reach the input sensor after multiple pick attempts, but the page was later detected at the input sensor while waiting for any page(s) ahead to clear the paper path. Possible cause is that the page is delayed at the alignment gate.
200.35	Failed to create hsync during auto alignment
200.36	Lost hsyncs during auto alignment
200.37	Timeout on data collection during auto alignment
200.38	Interpage servo gap is smaller than expected for printhead offset target evaluation
200.39	Auto alignment is taking too long to run.

Paper jam error codes (200-series) (Continued)

Error	Description
200.40	Invalid sample count in auto alignment.
200.41	ZW adder out of range in auto alignment.
200.42	Rogue sheet is at the manual feed sensor while flushing the paper path prior to declaring MPF source empty.
200.43	The paper is at the input sensor before interruption occurs. Possible causes include bouncy sensor or an exceptionally small gap, perhaps due to the paper being pre-staged in the source tray.
201.00	Paper jam between input and exit sensor
201.01	Transport motor identification failed to identify either motor after two tries.
201.02	Exit sensor never made by leading edge of page. Also known as internal jam.
201.03	Video never started on the page at the input sensor within two inches after hitting the input sensor
201.05	Restart attempted after an internal jam without the cover open/close event. It is likely that the jam was never cleared.
201.25	Exit sensor never made by leading edge of media when feeding out the media that was detected during warm-up.
201.26	Page at fuser nip before fuser started ramping toward desired temperature. Indicates code may be receiving more hall interrupts than intended
201.27	Page at fuser nip before fuser reached acceptable operating temperature. Page arrived at fuser earlier than expected, so it was probably staged
202.00	Paper jam around exit sensor.
202.01	Exit sensor never broke on the trailing edge of the sheet at the exit sensor.
202.02	Exit sensor never broke from sheet ahead of page heading toward the exit sensor.
202.06	Exit sensor bounced
202.13	Exit sensor covered, media not expected (media not in machine during warm-up)
202.25	Exit sensor never broke from the sheet ahead of the page heading toward the exit sensor when feeding out the media detected during warm-up.
202.26	Trailing edge never cleared exit sensor when feeding out media that was detected during warm-up.
202.32	Long media or shingled multi feed stopped before sending to duplex.
231.00	Duplex jam while reversing into the device
231.01	Duplex sensor never made by leading edge reversing into the duplex.
231.02	Bouncy duplex sensor never made.
232.00	Duplex jam while staging in the device
232.01	Duplex sensor never broke by the sheet ahead after reversing into the duplex.
232.02	Page in duplex ahead of current reversing page never staged.
233.00	Duplex jam while picking from the device
233.01	Page in duplex never picked.
233.02	Feed error picking from the duplex.

Paper jam error codes (200-series) (Continued)

Error	Description
233.03	Paper never reached the input sensor, but was detected at the manual feed sensor.
234.01	Duplex sensor covered during warm-up.
235.01	Invalid duplex media
241.00	Paper jam near tray 1.
241.10	Second pick attempt failed from Tray 1
241.12	Second pick from manual feeder, tray 1, or feeder failed when the media was in the source while other sheets were committed to the paper path.
241.16	Failed to feed from tray 1. Pages in the paper path have been flushed to the output bin.
241.17	MISIDENTIFIED SMALL GAP JAM. Engine detected small gap at the manual feeder sensor, attempted to open the gap by stopping the feed rolls, trailing edge was seen at the input sensor, manual feeder sensor is no longer covered.
241.18	MISIDENTIFIED NO GAP JAM. Engine detected no gap at the manual feeder sensor, attempted to open the gap by stopping the feed rolls, trailing edge was seen at the input sensor, manual feeder sensor is no longer covered.
241.19	Second pick attempted failed from Tray 1, no pages printed since calling a 241.10 or a prior 241.19.
242.00	Paper jam near tray 2.
242.01	Took too long to ramp up dc feed motor
242.08	Received lots of dc feed interrupts before losing them
242.10	Second pick attempt failed from Tray 2
242.12	Second pick from manual feeder, tray 1, or feeder failed when media was in the source, other sheets were committed to the paper path.
242.16	Failed to feed from tray 2. Pages in the paper path have been flushed to the output bin.
251.00	Paper jam near the manual feeder.
251.10	Second pick attempt failed from manual feeder.
251.11	Failed to feed from manual feeder. Pages in the paper path have been flushed to the output bin.
251.12	Second pick from manual feeder, tray 1, or feeder failed when media was in the source while the other sheets were committed to the paper path.
251.19	Media never reached the input sensor from the manual feeder.

Service error codes

Service error codes are generally non-recoverable except in an intermittent condition when the printer can be put into POR to temporarily recover from the error condition.

Service error codes (9xx)

Error	Description
Engine software service errors	
902.xx	Engine software error
DC pick motor errors	
914.00	DC pick motor error
914.01	Lost encoder feedback
Transfer service errors	
917.00	Transfer service error
917.01	Transfer servo result too low.
917.02	Immediate transfer servo indicates that the HVPS requires erase lamps.
Fuser service errors	
920.00	Under temperature during steady state control.
920.01	Fuser took too long to heat up after transitioning to new enhanced mode.
920.02	Fuser fell too far below desired temperature while printing.
920.03	Fuser too cool while checking for slope change.
920.04	Fuser too cool when heating to desired temperature after slope change.
920.05	Fuser under temperature while printing
920.06	Fuser under temperature while printing
920.07	Fuser under temperature while printing
920.08	Fuser temperature did not increase after IR recovery.
920.20	Belt fuser under temperature during steady state control. This can occur in printing or standby modes.
921.00	Under temperature during standby control.
921.01	Fuser temperature did not reach standby temperature after two attempts
922.00	Fuser failed to ramp to target temperature
922.01	Fuser did not reach standby temperature in time (standby control)
922.02	Hot roll took too long to reach the beginning lamp detection temperature.
922.03	Hot roll reached final lamp detection temperature, but took longer than largest time in lookup table.
922.04	Hot roll timed out in trying to reach the final lamp detection temperature.
922.05	Did not roll over to a steady state control in time after the hot roll lamp detection.
922.06	Hot roll did not reach the operating temperature in time (new enhanced control).

Service error codes (9xx) (Continued)

Error	Description
922.07	Media reached fuser nip, and fuser is under temperature
922.08	Fuser warm-up failure (motor start condition)
922.09	Fuser warm-up failure (compression set)
922.20	Belt fuser failed to reach the preheat temperature for the motor to start during warm-up.
922.21	Belt fuser was under temperature when the media reached the fuser nip.
923.00	Fuser is over temperature.
923.01	Fuser is over temperature. This applies to the fuser and belt fusers.
924.00	Open thermistor check.
924.01	Open thermistor check failure. This applies to the fuser and belt fusers.
924.02	Open thermistor check failure. The ADC failed to converge. Possible noisy thermistor signal. This applies to the fuser and belt fusers.
925.00	Wrong fuser lamp installed.
925.01	Lamp detection performed and found error.
925.02	Too hot to do lamp detection, and NVRAM bit indicates previous wrong lamp detected.
Fan service errors	
927.00	Service fan error
927.03	Main fan took too long to ramp up
927.04	Main fan is under speed or stalled during speed adjustment state
927.05	Main fan overspeed during speed adjustment state.
927.06	Main fan capture data is invalid, and speed control is at maximum in fan control idle state
927.07	Main fan capture data is invalid, and speed control is at maximum in fan control adjustment state.
Printhead service errors	
931.00	No first hsync
931.01	No first hsync
932.00	Lost hsyncs
932.01	Lost hsyncs
933.01	Printhead boost signal failure
934.00	Mirror motor lost lock.
934.01	Mirror motor lost lock.
935.10	Printhead sweep error, swept through Hz range without finding the resonant frequency
935.11	Printhead sweep error, autosweep hw state
935.12	Printhead sweep error, coarse sweep state
935.13	Printhead sweep error, init fine sweep state

Service error codes (9xx) (Continued)

Error	Description
935.14	Printhead sweep error, fine sweep state
935.15	Printhead sweep error, check prelim amp state
935.16	Printhead sweep error, enable amp Kp state
935.17	Printhead sweep error, amp Kp failed to converge
935.18	Printhead sweep error, enable amp Ki state
935.19	Printhead sweep error, amp Ki failed to converge
935.20	Printhead sweep error, enable offset controller state
935.21	Printhead sweep error, load scan regs state
935.22	Printhead sweep error, fwd and rev capture times differ by too much
935.23	Printhead sweep error, check sweep accuracy state
935.24	Printhead sweep error, reserved
935.25	Printhead sweep error, detected resonant frequency out of expected range
935.26	Printhead sweep error, timed out waiting for end of sweep
Transport motor service errors	
936.01	No lock detected at normal motor start
936.02	No lock detected at motor start for motor ID
936.03	No halls detected at motor start
936.04	Failed to stop within timeout
936.05	Stall detected during speed control
937.00	Main transport motor lost lock
937.01	Main transport motor lost lock, detected by engine control
937.02	Overspeed detected during position control
937.03	Overspeed detected during speed control
Power supply service errors	
940.00	LVPS service error
940.01	Line frequency outside allowed range of 45Hz-64Hz
940.02	Line frequency below 43Hz
940.03	No zero cross detected on belt fuser model

Diagram of the printer menus

Not all menus or selections will be available on all models or in all situations. These are accessed through the driver.

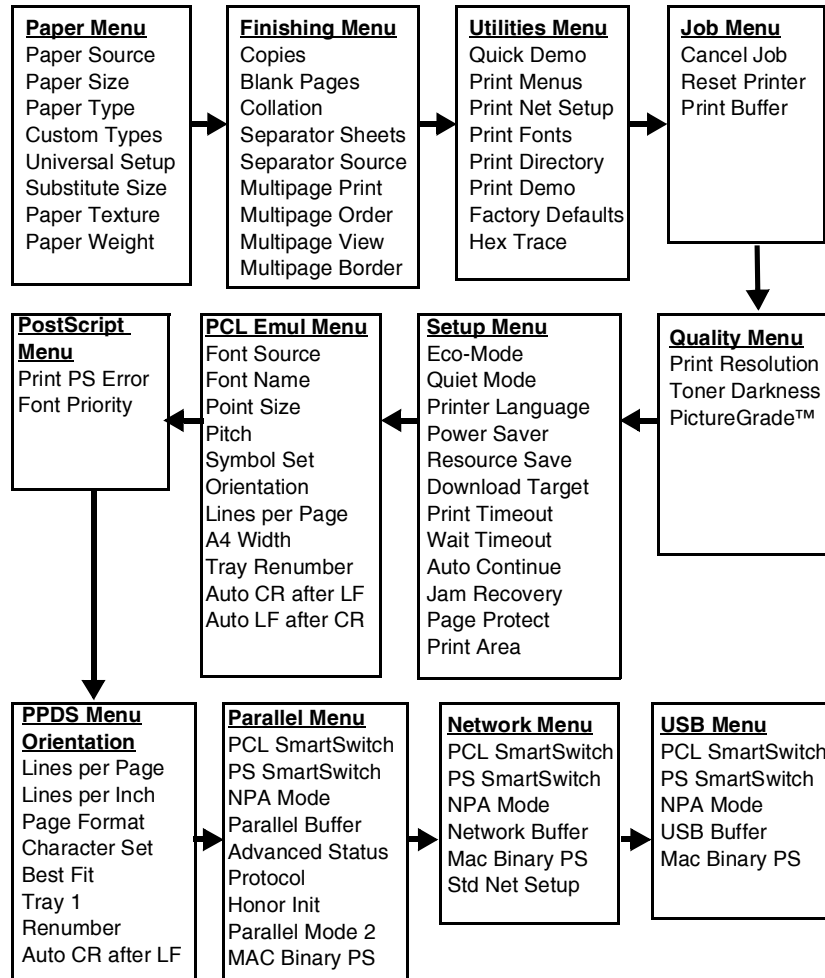

Symptom tables

POST symptom table

Note: Investigate any displayed codes before proceeding with these symptoms. For example, a missing toner cartridge will prevent POST from completing.

Symptom	Action
The main motor, cooling fan, and fuser do not come on.	See “Cover interlock switch service check” on page 2-47.
POST completes, except one or more lights do not come on.	See “Operator panel service check” on page 2-50.
None of the lights come on.	See “Operator panel service check” on page 2-50.
Main motor does not come on.	See “Main motor service check” on page 2-49.
Fan does not come on.	See “Cooling fan service check” on page 2-47.
Fuser does not cycle.	See “Fuser service check” on page 2-48.
Fuser does not turn on and off.	See “Fuser service check” on page 2-48.
The paper feed picks and tries to feed media.	See “Paper feed service checks” on page 2-50.

Printer symptom table

Symptom	Action
Dead machine (no power).	See “Dead machine service check” on page 2-48.
Fan noisy or fan not working.	See “Cooling fan service check” on page 2-47.
Fuser parts melted.	See “LVPS/HVPS service check” on page 2-49.
Toner not fused to the media.	See “Fuser service check” on page 2-48 or “Solving print quality problems” on page 3-57.
Paper jams.	See “Paper feed service checks” on page 2-50.
Main motor noisy or not moving.	See “Main motor service check” on page 2-49.
Media skew.	See “Paper feed service checks” on page 2-50.
Printer not communicating with host.	See “Parallel or USB port service check” on page 2-52.
Front access door will not close.	See “Cover interlock switch service check” on page 2-47.
Operator panel button not responding.	See “Operator panel service check” on page 2-50.
Operator panel lights are off or very dim.	See “Operator panel service check” on page 2-50.
Blank page.	See “Blank page” on page 2-53.
Black page.	See “Black page” on page 2-54.
Heavy background.	See “Heavy background” on page 2-54.
Light print.	See “Light print” on page 2-56.
White or black lines or bands.	See “White or black lines or bands” on page 2-56.
Toner on back of page.	See “Toner on back of page” on page 2-56.
Media never picks.	See “Media never picks” on page 2-51.
Media feeds continuously.	See “Media picks during POST and/or continuously” on page 2-50.
Media wrinkled or bent.	See “Media “trees,” wrinkles, stacks poorly, or curls” on page 2-52.
Print quality problems <ul style="list-style-type: none"> • Light print • Blurred characters • Toner on both sides of media • Toner not fused • Streaks • Blank pages 	See “Solving print quality problems” on page 3-57.

Service checks



Service checks which involve measuring voltages on the LVPS/HVPS (low voltage power supply/ high voltage power supply board) should be performed with the printer positioned on its back side.

Note: When making voltage readings, always use frame ground unless another ground is specified. See the wiring diagram in the back of the book for more information.

Controller board service check

Controller board service check

FRU	Action
Controller board assembly Warning: Do not replace the operator panel and controller board at the same time. Each card contains the printer settings. When either of these cards is new, it obtains some of the settings from the other card. Settings are lost when both are new and replaced at the same time.	<p>POST (Power-On Self Test)</p> <p>Note: The printer should complete POST in approximately 30 seconds. If the printer fails to display lights or activate the drive motor, fuser or fan, then check the following order:</p> <ol style="list-style-type: none"> 1. Power to the LVPS/HVPS 2. Power from the LVPS/HVPS to the controller board 3. Cables are plugged in correctly, especially for the operator panel. The printer will not power-up without a functioning operator panel. 4. The controller board assembly 5. The operator panel, see “Operator panel service check” on page 3-50.
	<p>Verify +24 V dc input from the LVPS/HVPS.</p> <ol style="list-style-type: none"> 1. Turn the printer off. 2. Disconnect the LVPS/HVPS cable from the controller board at J502. 3. Turn the printer on. 4. Verify +24 V dc on positions 6, 17, and 19 of the cable connector (LVPS/HVPS). 5. If voltage is correct, then check the continuity in the other conductors of the cable. If the cable is good, then turn the printer off, and check the connectors to the controller board. 6. Verify that pins 10, 12, 14, 16, and 18 on both the cable and the card connector are grounded. 7. If grounds are not correct on the cable, but the cable passes continuity otherwise, then check the LVPS/HVPS. 8. If the grounds are not correct on the controller board, then replace the controller board. (Check with one probe on the connector pin and the other on the card's ground plane found at each screw head.)
	<p>Controller board voltage outputs</p> <p>Turn the printer off, and plug the LVPS/HVPS cable into J502 of the controller board. See the wiring diagram at the end of the book which identifies the voltages and grounds for a good controller board.</p> <p>Turn the printer off before plugging or unplugging any connectors.</p>

Controller board service check (Continued)

FRU	Action						
LVPS/HVPS	<p>Verify main power to controller board</p> <p>With the printer off, unplug the LPS/HVPS cable at J502 on the controller board. Verify grounds on pins 10, 12, 14, 16 and 18 for both the cable and the controller board. If any of these grounds are incorrect, then check the cable for continuity. If the cable fails continuity, then call the next level of support.</p> <p>Turn the printer on with the cable still unplugged, and verify the following on the cable (controller board will not be powered):</p> <table border="1"> <thead> <tr> <th>Pins</th> <th>Voltage</th> </tr> </thead> <tbody> <tr> <td>6, 17, 19</td> <td>+24 V dc</td> </tr> <tr> <td>1, 3-5, 11, 13, 15</td> <td>+5 V dc</td> </tr> </tbody> </table> <p>If any of the voltages are incorrect, then replace the LVPS/HVPS. See “Dead machine service check” on page 2-48.</p>	Pins	Voltage	6, 17, 19	+24 V dc	1, 3-5, 11, 13, 15	+5 V dc
Pins	Voltage						
6, 17, 19	+24 V dc						
1, 3-5, 11, 13, 15	+5 V dc						

Cooling fan service check

FRU	Action
Cooling fan	<p>Make sure the fan cable plug is properly seated at J9 (controller board).</p> <p>Turn the printer on. Within a few seconds, the controller board assembly should apply +24 V dc to pin 2.</p> <ul style="list-style-type: none"> • If voltage is not present, then check or replace the controller board. See “Controller board removal” on page 4-6. • If voltage is present, then check pin 1 for 24 V dc as well. If it is close to 24 V dc while the fan is still idle, then replace the fan. See “Fan removal” on page 4-16.

Cover interlock switch service check

Note: Make sure a toner cartridge assembly is installed and the cover closes all the way, engaging the cover open switch lever.

FRU	Action
Cover interlock switch	<p>Disconnect the cover interlock cable from the controller board at J7.</p> <p>With the printer turned off, verify continuity between cable pin 1 and pin 2 with the door closed and discontinuity with the door open.</p> <p>Verify continuity between cable pin 1 and pin 3 with the door open and discontinuity with the door closed.</p> <p>Verify discontinuity between cable pins 2 and 3 whether the door is open or closed.</p> <ul style="list-style-type: none"> • If either fails, then replace the cover interlock switch. • If both pass continuity, then turn the printer on, and measure +5 V dc on pin 2 at J7 on the controller board. • Verify pin 3 at J7 is ground. • If voltage or ground is not present, then see “Controller board service check” on page 2-46 for more information.

Dead machine service check



CAUTION: Check the AC line voltage. The voltage should be within the following limits:

- 100 V ac (volts alternating current): 127 V ac for the 110 V printer
- 200 V ac: 240 V ac for the 220 V printer

FRU	Action
 LVPS/HVPS	Unplug the printer. Remove the LVPS/HVPS, and check the fuses for continuity. <ul style="list-style-type: none"> • If open, then replace the LVPS/HVPS. • If not open, then check the switch continuity across its conductors with the switch on. Turn the switch off. Plug the AC line into the LVPS/HVPS, and switch unit on. <p>Note: AC voltages are exposed at several places on the board. Do these verifications, and then unplug the AC cord from the power supply:</p> <ul style="list-style-type: none"> • Verify 24 V dc on pins 6, 17, and 19 at CN201. • Verify approximately 5V on pins 1-5, 11, 13, and 15. • If voltages are not correct, then replace the LVPS/HVPS. • If voltages are correct, then check the controller board. See “Controller board removal” on page 4-6.

Fuser service check

When toner is partially fused to the media, it is usually caused by low fuser temperature.



The line voltage to the printer must be within the following limits:

- 100 V ac: 127 V ac for the 110 V model printer
- 200 V ac: 240 V ac for the 220 V model printer



This printer uses a belt fuser and therefore does not have a lamp.

Fuser service check

FRU	Action
 Fuser power cable LVPS/HVPS Fuser	Unplug the printer, and disconnect the fuser cable plug from the LVPS/HVPS board connector at CN102. Check for continuity across the fuser by checking across the connector pins. <ul style="list-style-type: none"> • If there is continuity, then check the LVPS/HVPS. See “LVPS/HVPS service check” on page 3-49. • If there is no continuity, then disconnect the fuser power cable at both ends and check each conductor for continuity. Replace cable if necessary. • If the cable tests good, then replace the fuser. Reconnect the cables, turn the printer on, and at &12, check for approximately +5 V dc on pin 1 and ground on pin 2. If line voltage is incorrect on pin 1, then see “Controller board service check” on page 2-46 for more information.
 Fuser	Disconnect the thermistor cable from J12 on the controller board. Measure the resistance across the ends of the thermistor cable. Replace the fuser assembly if the resistance is lower than 1K ohm or shorted. <p>Note: Resistance measures approximately 400K ohms when cool and 1K ohms hot.</p>

LVPS/HVPS service check

FRU	Action
 <p>LVPS/HVPS</p>	<p>LVPS portion of board Fuses that open typically indicate a faulty LVPS/HVPS.</p> <p>Disconnect the power cable, and open the LVPS/HVPS enough to test the switch. The switch will show continuity across the conductors with a meter when the switch is on. If the switch is good, then see “Dead machine service check” on page 2-48 for more diagnostics.</p> <p>HVPS portion of board Problems with the HVPS are exhibited in the print quality. See “Print quality service checks” on page 2-53 for more information.</p>

Main motor service check

FRU	Action						
 <p>Main motor gear drive Main motor cable LVPS/HVPS Controller board</p> <p>Warning: <i>Do not</i> replace the operator panel and controller board at the same time. Each card contains the printer settings. When either of these cards is new, it obtains the settings from the other card. Settings are lost when both are new and replaced at the same time.</p>	<p>Turn off the printer, and unplug the main motor cable at J17. Turn on the printer, and check for the following voltages at J17:</p> <table border="1" data-bbox="768 846 1182 974"> <thead> <tr> <th>J17 pins</th> <th>Voltages</th> </tr> </thead> <tbody> <tr> <td>Pins 1-4, 6</td> <td>Approx. 5 V dc</td> </tr> <tr> <td>Pins 7-9</td> <td>18 V dc: 24 V dc</td> </tr> </tbody> </table> <p>Verify ground at pin 5 for both the card and cable.</p> <ul style="list-style-type: none"> If these voltages are correct, then check the main motor cable for continuity. <ul style="list-style-type: none"> Remove the left side cover to access the connector on the motor. If continuity exists on each wire, then replace the main motor gear drive which includes the motor. If continuity does not exist on one or more of the wires, then call the next level of support. If these voltages are not correct, then see “Controller board connector pin values” on page 5-2, or replace the controller board. See “Controller board removal” on page 4-6. 	J17 pins	Voltages	Pins 1-4, 6	Approx. 5 V dc	Pins 7-9	18 V dc: 24 V dc
J17 pins	Voltages						
Pins 1-4, 6	Approx. 5 V dc						
Pins 7-9	18 V dc: 24 V dc						

Operator panel service check

Inspect the operator panel cable for damage. Make sure the cable is plugged in securely. Run POST, and check each light for proper operation. See **“Power-On Self Test (POST) sequence” on page 2-2.**

LED Operator panel service check

FRU	Action
Operator panel (LED) Controller board Warning: Do not replace the operator panel and controller board at the same time. Each card contains the printer settings. When either of these cards is new, it obtains the settings from the other card. Settings are lost when both are new and replaced at the same time.	<p>Lights</p> <p>If none of the lights come on, then open the controller board cage and locate the operator panel connector at J5. Make sure the cable is properly connected to the controller board and the controller board has input voltage to it.</p> <p>With the printer on, verify the following without disconnecting the cable:</p> <ul style="list-style-type: none"> • Pins 1, 3, 5, and 6: 3.3 v • Pin 2: 5 v • Pins 4 and 7: GND <p>If these are approximately correct and the operator panel is not functioning, then replace the operator panel.</p> <p>If any are incorrect, then see “Controller board service check” on page 3-46.</p>
	<p>Buttons</p> <p>If the buttons do not respond, then replace the operator panel. There is no test or repair for the faulty switches on the operator panel.</p>

Paper feed service checks

Paper jam error indication during POST

FRU	Action
Fuser (exit sensor)	If the exit sensor flag, which is visible at the back of the fuser, is in any position other than vertical, then the printer will display a paper jam. Make sure the flag is operating freely. Replace the fuser if the sensor is damaged.
Input/duplex sensor Manual feed sensor	Make sure the input paper feed sensors are working properly. A stuck or incorrectly installed sensor causes a paper jam.

Media picks during POST and/or continuously

FRU	Action
ACM Manual feed clutch	Remove the tray, lower the ACM pick tires, and then turn on and verify that the rollers do not turn during POR. If so, then replace the ACM manual feed clutch.

Media picks but stops halfway through the printer

FRU	Action
Input/duplex sensors (under print cartridge assembly) Input sensor (manual)	<p>Make sure the input sensors are working properly.</p> <p>Check for a broken or stuck flag on the input sensors. Clear anything that keeps the flags from rotating freely.</p> <p>Make sure the cables are seated on the controller board at J27 (input/duplex sensor) and J23 (manual input).</p> <p>Check for +5 V dc on pin 2 and 5 at J27 (input/duplex sensors) and pin 2 at J23 (Input sensor). Voltages on pins 1 and 4 at J27 pin 1 at &23 should charge as the flags intersect with the sensor.</p> <ul style="list-style-type: none"> • If correct, then replace the input paper feed sensor. • If these voltages are not correct, then replace the controller board. • Check the pick tires. Clean or replace as necessary.

Media never picks

FRU	Action
Paper feed (pick tires) tray 1 Paper feed (pick tires) tray 2 Media drive ASM Media feed clutch ASM Manual feed clutch ASM P/U and manual feed solenoid ACM drive shaft	<p>Open the left cover, and verify that the solenoids and clutches are functioning when an attempt is made to feed the media.</p> <p>Make sure the rubber tires on the ACM are installed and clean.</p> <p>Replace the tires, ACM drive, clutch assemblies, solenoids, or drive shaft as necessary.</p>

Media occasionally mispicks or picks multiple sheets at once

FRU	Action
Tray 1 Tray 2 (option)	<p>Check tray for media catch points.</p> <p>If the sheet being fed stops momentarily, then the ACM applies additional vertical force, causing additional sheets to feed.</p> <p>Do not mix media types in one tray.</p>
Paper pick tires (Tray 1 or tray 2)	<p>Check the tires in the ACM assembly for signs of wear or damage.</p> <p>Replace the tires as necessary.</p>
ACM clutch Manual feed clutch Media feed clutch ASM (tray 1 only) Manual feed clutch solenoid	<p>Open left cover, and observe the solenoid and clutch actions at the ACM and manual feed shafts as a print job is attempted.</p> <p>Replace the faulty part.</p>
Controller board P/U and manual feed solenoid ASM.	<p>Disconnect the solenoid cable at J26 on the controller board and measure the resistance across cable pins 1 and 2.</p> <ul style="list-style-type: none"> • The resistance should be approximately 70 ohms. • If it is not, then replace the solenoid. • If the resistance is approximately 70 ohms, then check the controller board. Pin 1 at J26 should be +24 V dc. See “Controller board service check” on page 2-46 for more information. <p>Replace controller board as necessary.</p>

Media skews

FRU	Action
Paper feed (pick tires) tray 1 Paper feed (pick tires) tray 2 Tray 1 Tray 2 (option)	Check tires for debris. If tires are new, then try reversing each on its hub. Check side guides on Tray 1 and Tray 2. Guides set for a full stack of media may be too wide when the stack is short.

Media “trees,” wrinkles, stacks poorly, or curls

FRU	Action
Fuser	<p>This problem is most likely due to a worn backup roll. It causes the printer to run hotter than required for the media being printed. Excessive heat can cause media treeing problems, poor stacking, or curl.</p> <p>Print the menu sheet (press and release ▷ with the printer in ready mode).</p> <p>Look at the media settings. Some, such as card stock or rough texture, may require a higher fuser temperature, which leads to more of these problems (except stacking) in plain paper.</p> <ul style="list-style-type: none"> • Change settings using the printer driver. • Use the local printer setup utility (included on the CD) to change the NVRAM settings. <p>Try a different ream of paper. Moist media has a higher tendency to crease (treeing) and curl.</p>

Parallel or USB port service check



1. Perform a print test to make sure the printer prints correctly. Verify  is on, then press ▷ to print menu settings.
2. Be sure the printer parallel cable is designed for bidirectional printing.
3. Be sure the user’s application is set up correctly.
4. If the internal print test page prints correctly, then the user’s application/printer driver is set up correctly, and the correct bidirectional parallel cable is installed, but the printer still fails to print on command from the host computer, replace the controller board.
5. Check the USB cable for continuity.

Print quality service checks

Note: Ensure the cover closes tightly. A gap in the opening may allow light to expose the photoconductor, resulting in a 'dirty' print. Extreme environmental conditions, temperatures, and humidity will affect the print quality.

Using print quality test pages

To help isolate print quality problems, like streaking, print test pages using the print quality test pages. To print the print quality test pages:

1. Enter Configuration Menu.
 - a. Turn off the printer.
 - b. Open the front access door.
 - c. Turn on the printer while pressing and holding ▷.
 - d. When the  light stays on, close cover.
 - e. Wait (approximately 10 seconds).
2. Press and release ✕ three times until the ▷ and  lights come on.
3. Press and hold ▷ until all the lights flash to initiate printing the quality test pages. Four pages print to help evaluate print quality. The first page has various fonts and a graphic, the second page is gray with graphics, the third page is black, and the last page is blank. Once the media exits into the output bin, the printer returns to the home state (four top lights on).
4. Use the test pages to isolate problems such as light or toner streaks. See **“POST symptom table” on page 2-44** for solutions to these problems.

To exit print quality test pages, turn the printer off.

Note: Refer to the print defects guide at the end of the manual for repeating defects.

Blank page

FRU	Action
Toner cartridge (not a FRU)	Remove the toner cartridge, and gently shake it to evenly distribute the toner. Check for cartridge damage.
 Printhead LVPS/HVPS Controller board	<p>Blank pages can be caused by a defective printhead assembly, LVPS/HVPS, or controller board.</p> <ul style="list-style-type: none"> • Printhead errors typically result in printer service errors unless there is blockage of the beam or dust on the lens. Check the lens and opening for blockage. • Blank pages typically are caused by the PC roll not being properly charged. Try a different PC kit. • With the cartridge out, check the spring loaded contacts on the right side for free motion. None should be ground except for #4 contact from the front. <p>Unplug the printer, and check the cable continuity between the LVPS/HVPS connector marked OPC (at CN202) and the corresponding wire form (spring) found about 14 mm above and to the right of the transfer roll gear.</p> <ul style="list-style-type: none"> • If there is no continuity, then call the next level of service. <p>Try a different toner cartridge and PC kit.</p> <ul style="list-style-type: none"> • If those fail, then replace the LVPS/HVPS, controller board, or the printhead in that order. <p>Also, see “Solving print quality problems” on page 3-57.</p>

Black page

Note: Incorrect laser exposure or incorrect charging of the photoconductor causes an all black page. Always verify the same results from a different toner cartridge assembly and developer before proceeding.

FRU	Action
Toner electrodes (not a FRU)	<p>Check the three rearward electrodes below the toner cartridge assembly for contamination, damage, or a short to ground. Correct as necessary.</p> <p>Check continuity between the cable (DEV, TAR, and doctor blade) connection PCN3 and on the contact tips below the toner cartridge assembly.</p> <ul style="list-style-type: none"> • If continuity fails, then call the next level of support.
 <p>LVPS/HVPS board Controller board Miscellaneous cables</p>	<p>With the printer off, disconnect the LVPS/HVPS cable from J502 on the controller board.</p> <p>Turn the printer on, and verify +24 V dc on pins 17 and 19 of the cable.</p> <p>Verify +5 V dc on pins 1, 3, 5, 13, and 15.</p> <p>Verify ground on pins 10, 12, 14, 16, and 18.</p> <ul style="list-style-type: none"> • If any of the values are incorrect, then replace LVPS/HVPS board. • If the grounds are incorrect, then check ground paths. • Check continuity in the cable. If the cable is bad, then call the next level of support. • If the values are correct and the toner electrodes are good, then replace the controller board. • See the “LVPS/HVPS service check” on page 2-49 and the “Controller board service check” on page 2-46, if necessary.

Heavy background

Poor development or poorly charged toner particles cause excessive background. This is more noticeable as the toner cartridge nears end-of-life.

FRU	Action
Toner cartridge (not a FRU) PC Kit (not a FRU)	<p>Check the toner darkness setting in the driver. Try a lower setting.</p> <p>Make sure the toner cartridge and PC Kit are correctly installed and the high voltage contacts are clean.</p> <p>If the toner cartridge and PC Kit are installed correctly, then try a new PC Kit first and then toner cartridge.</p>
 <p>LVPS/HVPS Controller board</p>	<p>Check the contacts for correct installation and contamination where contact is made between the toner cartridge assembly and spring contacts which connect to the LVPS/HVPS board at PCN3. Clean as necessary.</p> <p>If this does not correct the problem, then replace the following FRUs one at a time in the order shown:</p> <ul style="list-style-type: none"> • LVPS/HVPS board (See “Black page” on page 3-54 for pin values.) • Controller board

Partial blank image/white spots (no repeating pattern)

FRU	Action
Toner cartridge (not a FRU)	Remove the toner cartridge assembly, and gently shake the assembly to evenly distribute the toner. Check to make sure that the laser light path is not blocked. If the toner cartridge is low, then try a new one.
Paper (not a FRU)	Make sure recommended media is being used. Check the media settings in the printer driver. A heavier media may require higher heat to properly fuse.

Variation in image density horizontally across page

FRU	Action
PC Kit (not a FRU)	The charge roll may have an unbalanced force against the PC (photoconductor) drum. Try a new PC Kit.
Transfer roll	Note: Do not touch the transfer roll except at its ends. Place a sheet of paper over the roll to prevent damage from finger oils or hand lotion. Check the springs in the left and right transfer roll bearings. The bearing assemblies should support the transfer roll, applying evenly distributed forces to the PC drum. Replace the transfer roll assembly if the springs or bearings show signs of damage or fatigue. Inspect the transfer roll for signs of wear, damage, or contamination. Replace as necessary.

Poor fusing of image

FRU	Action
Fuser	The fuser may not be operating at the proper temperature to fuse the toner to the paper. See " LVPS/HVPS service check " on page 2-49 for more information. Try changing the setting to heavier paper or even card stock.
Media (not a FRU)	Make sure recommended media is being used. Check the media settings in the printer driver.

Light print

FRU	Action
Toner cartridge (not a FRU)	<p>Make sure the toner cartridge and PC Kit are installed correctly and that the toner cartridge is not low on toner.</p> <p>If the problem continues, then install a new toner cartridge.</p> <p>Recheck condition before replacing PC Kit, if necessary.</p>
 Transfer roll LVPS/HVPS card	<p>Check the transfer roll for signs of toner buildup and contamination.</p> <p>Inspect the HVPS contact (transfer roll) for contamination.</p> <p>Verify the high voltage cable is plugged into the LVPS/HVPS.</p> <p>If all components appear free of contamination, then replace the following FRUs one at a time in the order shown:</p> <ul style="list-style-type: none"> • Transfer roll • LVPS/HVPS card

White or black lines or bands

FRU	Action
Print cartridge assembly (not a FRU) Developer drive coupling assembly Main motor gear drive	<p>Banding appears as light or dark horizontal lines on a uniformly gray page or on a page with a large area of graphics. Banding is primarily due to a variation in the speed of the media as it feeds through the printer, especially in the developer and transfer process. It may also be a result of overly dry or moist environments.</p> <p>With the printer off, check to make sure that the laser beam is not blocked.</p> <p>Inspect the toner cartridge and paper feed components, especially the drive coupler and drive gears for debris, binds, or damage.</p>

Toner on back of page

FRU	Action
Photoconductor kit (not a FRU)	<p>Print a menu page found under Utilities, and check settings for media type.</p> <p>Inspect the overall paper path for signs of spilled toner.</p> <p>Gently clean the contaminated areas with a soft cloth.</p>
Fuser	<p>Inspect the fuser for signs of contamination.</p> <p>Replace the fuser as necessary.</p>
Transfer roll	<p>A transfer roll contaminated with toner can cause toner to transfer to the back of pages.</p> <p>Inspect the transfer roll for contamination and its cable for continuity.</p>
HVPS or controller board	<p>Loss of the proper high voltages can cause excessive toner to contaminate the transfer roller. None of these voltages can be measured, but the contacts and continuities can be checked. To check the lower voltage, see J502 on the wiring diagram. Replace the LVPS/HVPS or controller board as necessary.</p>



Solving print quality problems

Note: Refer to the print defects guide at the end of the manual for repeating defects.

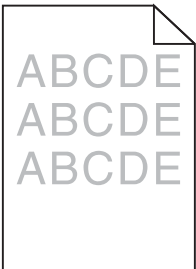
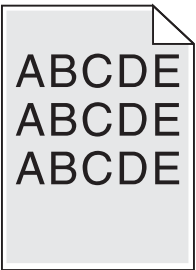
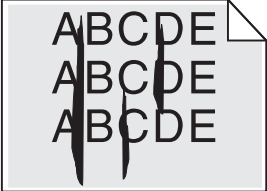
Print quality problems

Problem	Cause/action
<p>Light or blurred characters.</p> 	<p>Light print See “Light print” on page 2-56.</p> <p>The toner cartridge may be getting low on toner:</p> <ul style="list-style-type: none"> • Remove the toner cartridge and toner cartridge assembly. • Shake it from side to side to redistribute the toner. • Reinstall it and recheck for condition. • Make sure to use the recommended print media (see media types and sizes in the <i>User's Reference</i>). • Use MarkVision™ Professional to define the custom type setting for media type, media texture, or media weight. • The toner cartridge or PC Kit may be defective. Replace the PC Kit first and recheck. <p>Blurred characters Blurred images, including characters, are usually caused by a defective printhead.</p> <p>Vertical white lines See “Vertical streaks” below.</p> <p>Vertical white lines may be caused by the laser beam, which may be partially blocked. With the printer off, clear the path or clean the lens. The toner cartridge or fuser may be defective. Try a different toner cartridge. Inspect the fuser at its entry for debris.</p>
<p>Toner smudges appear on the front or back of the page.</p> 	<ul style="list-style-type: none"> • Make sure the media is straight and unwrinkled. • Replace the PC Kit, and recheck before replacing the toner cartridge. See “Toner on back of page” on page 2-56 for more information.
<p>Vertical or horizontal streaks appear on the page.</p> 	<p>Vertical streaks Something could be caught between the PC kit and the fuser. Check the paper path around the fuser entry. Try a different toner cartridge.</p> <p>Vertical white lines may be caused by the laser beam, which may be partially blocked. With the printer off, clear the path or clean the lens. The toner cartridge or fuser may be defective. Try a different toner cartridge. Inspect the fuser at its entry for debris.</p> <p>Horizontal streaks The toner cartridge or the fuser may be the cause due to excessive page count or defect. Replace as needed.</p> <p>If the lines are parallel and match the two intended ghost images, then the Form Type may be incorrectly set. Check those settings.</p> <p>The PC cleaner sump may be full. Replace the PC kit.</p>

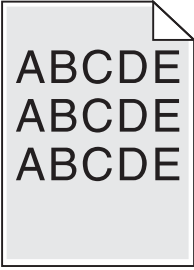
Print quality problems (Continued)

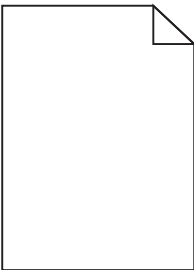
Problem	Cause/action
<p>Toner smears or rubs off the page.</p> 	<ul style="list-style-type: none"> • Toner is not being fused to the paper. Replace the fuser. • Change the media texture setting in the driver. If special media is being used, such as card stock or labels, then be sure to select the correct media type. • Try a different kind of paper. Paper designed for copiers gives the best quality fusing.
<p>The print is getting light, but the printer has not indicated it is low on toner.</p>	<ul style="list-style-type: none"> • Toner is becoming low in the cartridge. • The  light message does not display if the 1,500-page toner cartridge is installed. • Remove the toner cartridge, and gently shake it from side to side to redistribute the toner. • Replace the toner cartridge.
<p>The  light displays.</p>	<ul style="list-style-type: none"> • Remove the toner cartridge, and gently shake it from side to side to redistribute the toner. • Replace the toner cartridge.
<p>Solid black areas on transparencies</p>	<ul style="list-style-type: none"> • There is a mismatch in the transparency and what the software is expecting. • Choose a different fill pattern in the software program. • Remove the toner cartridge, and gently shake it from side to side to redistribute the toner. • Try a different type of transparency. • Replace the toner cartridge.
<p>Faint images or repetitive spots appear on the page.</p>	<ul style="list-style-type: none"> • Select a different media type or form type setting from the printer driver. • Try a different type of paper. Media designed for copiers gives the best quality. • Replace the toner cartridge.
<p>Pages are blank.</p> 	<ul style="list-style-type: none"> • The toner cartridge may be out of toner or defective. Replace the cartridge. • There may be a software error. Re-initialize the printer by turning it off and back on. • With the printer off, check the printhead beam path. If clear, then check for a printhead error on POR. See “Printhead service check” on page 2-60. • Also, see “Blank page” on page 3-53.

Print quality problems (Continued)

Problem	Cause/action
The printer is on and indicates ready, but nothing prints.	<ul style="list-style-type: none"> • Make sure the parallel or USB cable is not damaged and is firmly plugged into the connector on the back of the printer. • Make sure the toner cartridge assembly is installed properly. • Press and release \triangleright to print a menu settings page. <ul style="list-style-type: none"> - If a menu settings page cannot be printed, then contact the next level of support. - If a menu settings page can be printed, then the problem is one of the following: <ul style="list-style-type: none"> • Computer • Software program • Cable • (USB only) A failed controller board. Replace card. <p>Note: Test by unplugging USB and plugging it with the printer on. If the computer indicates "unknown device," then replace the controller board.</p>
Toner Low light is on and printing stops.	If a 3.5K or more page toner cartridge is being used and the Toner Low alarm is set to on, then the printer stops printing until the toner cartridge is replaced.
The Error light alone is on.	Make sure the printer front cover is closed.
The Toner Low light is blinking, and the Error light is on.	<ul style="list-style-type: none"> • Make sure the toner cartridge is installed correctly. • Install a new toner cartridge.
The media skews or buckles.	<ul style="list-style-type: none"> • Tray is overfilled or media is too loose. • Don't overfill Tray 1 or the optional Tray 2 (see media capacities in the media types and sizes table in the <i>User's Guide</i>). • Make sure the paper guides are flush against the edges of the media.
The media sticks together, resulting in the printer feeding multiple sheets.	<ul style="list-style-type: none"> • The friction between sheets is too high. • Remove the media from Tray 1 or Tray 2, and fan it. • Don't overfill Tray 1 or the optional Tray 2 (see media capacities in the media types and sizes chart in the <i>User's Reference</i>).
The media fails to feed from Tray 1.	<ul style="list-style-type: none"> • Frictional force between tires and media is less than resisting force. • Remove the media from Tray 1, and fan it. • Make sure Tray 1 is selected from the printer driver. Do not overfill the tray. • Check the condition of the rubber on the paper feed rolls. Replace if worn or contaminated. • Verify that the ACM clutch is functioning correctly.
The media fails to feed from the optional Tray 2.	<ul style="list-style-type: none"> • Incorrect tray selection or inadequate picking force by tires. • Make sure the correct tray and media type are selected from the driver. • Make sure the tray is pushed all the way in. • Remove the media from the optional Tray 2, fan it, and reload. • Check the rubber on the paper feed tires for dirt or any other debris. Replace as necessary. • Check the paper path in the tray for burrs or debris that may hinder media movement. • Make sure the media does not exceed the stack height indicator.
The Load Paper light is on even though there is media loaded in the optional Tray 2.	<ul style="list-style-type: none"> • The input sensor does not sense media after picking. • Make sure the tray is pushed all the way in. • Press \triangleright. • Check the feed tires. (See two preceding actions.)
The printer does not print after a paper jam has been cleared.	<ul style="list-style-type: none"> • The printer is waiting on the next command. • Clear all jams. • Press and release \triangleright, or open and close the printer cover to restart the printer. • Make sure the toner cartridge assembly is installed properly.

Print quality problems (Continued)

Problem	Cause/action
Unexpected characters print or characters are missing.	<ul style="list-style-type: none"> • Ensure correct printer driver is being used. • Select hex trace mode to determine what the problem is. • Restore factory defaults. • Make sure the parallel cable or USB cable is firmly plugged in at the back of the printer.
Jobs are not printing, and the error light is on solid.	<ul style="list-style-type: none"> • The printer is waiting for an appropriate command. • Make sure the toner cartridge assembly is installed properly. • Make sure the printer front cover is closed.
While in PostScript 3 emulation, the printer is flushing data (Ready/Data and Error lights are blinking).	<ul style="list-style-type: none"> • Ensure the correct PostScript driver is being used. • The printer doesn't have enough memory to print the job. Install more memory.

Printhead service check

FRU	Action
 <p>Printhead</p> <p>Note: New printhead must be aligned. See “Adjustment procedures” on page 3-9.</p>	<p>Turn the printer off.</p> <p>Disconnect the printhead cables from J8 and J100 on the controller board.</p> <p>Turn the printer on with the front door closed.</p> <p>On the controller board, verify +5 V dc on pin 10 at J8 and +5 V dc on pins 1 and 2 at J15.</p> <p>Verify grounds on pins 2, 4, and 7 at J8 and on pin 4 at J15.</p> <ul style="list-style-type: none"> • If voltages or grounds are incorrect, then check the controller board. See “Controller board service check” on page 2-46 for more information. • If voltages are correct, then replace the printhead (comes with cables).



Transfer roll service check

FRU	Action
 <p>Transfer roll</p>	<p>Note: Do not touch the transfer roll except at its ends. Place a sheet of paper over the roll to prevent damage from finger oils or hand lotion.</p> <p>Check the springs in the left and right transfer roll bearings. Do not try to move the left spring. The bearing assemblies should support the transfer roll, applying evenly distributed forces to the PC drum.</p> <p>Replace the transfer roll assembly if the springs or bearings show signs of damage or fatigue.</p> <p>Inspect the transfer roll for signs of wear, damage, or contamination.</p> <p>Replace as necessary.</p>

3. Diagnostic aids

Accessing service menus

There are two different test menus that can be accessed during POR to identify problems with the printer.

Configuration Menu	<ol style="list-style-type: none"> 1. Turn off the printer. 2. Open the front access door. 3. Turn on the printer while pressing and holding Continue ▷. 4. Close the front access door once the Error  light displays. 	<p>The Configuration menu group contains a set of menus, settings and operations which are infrequently required by a user. Generally, the options made available in this menu group are used to configure a printer for operation.</p> <p>See “Configuration menu selections” on page 3-4.</p>
Diagnostics Mode	<ol style="list-style-type: none"> 1. Turn off the printer. 2. Open the front access door. 3. Turn on the printer while pressing and holding Cancel ✕. 4. Close the front access door once the Error  light displays. 	<p>The Diagnostic menu group contains the settings and operations used while manufacturing and servicing the printer.</p> <p>See “Diagnostics mode selections” on page 3-8.</p>

Printing menus



Print Configuration menus by pressing and holding **Continue** ▷ until all of the lights flash, then release the button. The Configuration Mode Instruction page will print.

Print Diagnostic menus by pressing and holding **Continue** ▷ until all of the lights flash, then release the button. The **Ready/Data** light will blink when the page is being formatted and printed.

Note: The Configuration Mode Instruction page and Diagnostic menu page in this manual are samples only and may not match your specific machine.

Moving around the menu

“Configuration Menu printout” on page 3-2 and **“Diagnostics mode printout sample” on page 3-3** are similar to the instructions printed by following steps 1-3 above. These menu items are designated by the non-indented items listed along the left edge of the page (Bottom as printed from printer). These items are also unshaded.

- Press and release ✕ to move sequentially from one menu item to another.
- Press and hold ✕ to jump to home state (top four lights on).
- Press and release ▷ to move through the menu settings (indicated by  and  lights).
- This action rotates only through the possible settings of the selected menu item.

Configuration Menu printout

(sample only; use actual sheet).

Printer Settings Configuration

This page explains how to access the printer menu and change values. Menus are represented by Continuum, IndirectPrint, Paper Tray, and Load/Unload Paper Light sequences. Menu items and their values are indicated by Paper Jam and Error Light sequences.

Use the (Illustration) to help you find the menu and value you want to change. The Paper Jam and Error Lights show the current value of the menu item.

- 1 Press and release Continuum to advance through the menu and menu items to the one you need.
- 2 Press and release Continuum to advance through the menu and menu items to the one you need.
- 3 Press and hold Continuum until all of the lights cycle to perform the function or to save the value.
- 4 Press and hold Continuum until all of the lights cycle to return to the Home menu.
- 5 Turn the printer off to exit the menu.

Home, menu items, and values

Lexmark E260d, E260dn

Print Configuration Mode Instructions

Reset Factory Defaults
Hex Trace = Off
Off

Print Quality Test Pages
Reset Photoreconductor Counter
Reduced Curl = Off
Off

PPK Emulation = Deactivate
Deactivate
Activate

Demo Mode = Deactivate
Deactivate
Activate

Auto CR after LF = Off
Off

Auto LF after CR = Off
Off

Energy Conserve = On
Off

Fine Sharpening = Off
Off

MFA Mode = Auto
Off
Auto

Protocol = Fastbytes
Standard
Fastbytes

Parallel Mode = On
Off

MAC Binary PS = Auto
Off
On
Auto

MFA Mode = Auto
Off
Auto

MAC Binary PS = Auto
On
Off
Auto

Legend:
 ● Light On
 ○ Light Off
 ◐ Light Blinking
 ◑ Value

Printer Settings Configuration

This page explains how to access the printer menu and change values. Menus are represented by Continuum, IndirectPrint, Paper Tray, and Load/Unload Paper Light sequences. Menu items and their values are indicated by Paper Jam and Error Light sequences.

Use the (Illustration) to help you find the menu and value you want to change. The Paper Jam and Error Lights show the current value of the menu item.

- 1 Press and release Continuum to advance through the menu and menu items to the one you need.
- 2 Press and release Continuum to advance through the menu and menu items to the one you need.
- 3 Press and hold Continuum until all of the lights cycle to perform the function or to save the value.
- 4 Press and hold Continuum until all of the lights cycle to return to the Home menu.
- 5 Turn the printer off to exit the menu.

Home, menu items, and values

Lexmark E260d, E260dn

Network

Card Speed = Auto
Auto
10 Mbps, Half
10 Mbps, Full
100 Mbps, Half
100 Mbps, Full

MFA Mode = Auto
Auto

MAC Binary PS = Auto
Off
On
Auto

Reset Network SWAM

Legend:
 ● Light On
 ○ Light Off
 ◐ Light Blinking
 ◑ Value

Note: The light sequences change relative to the option on the printer.

Diagnostics mode printout sample

(sample only; use actual sheet)

Printer Diagnostics

This page walks you through the printer's menu and options. The printer's menu is organized by function, including: **Customize**, **Ready/Status**, **Power/Save**, and **Load/Unload Paper**. Light sequences are used to help you find the menu and value you want to change. The **Ready** lamp and **Error** light show the current value of the menu item.

- Press and release **Continue** to advance through the menu and menu items to the one you need.
- Press and release **Continue** to advance to the value you need.
- Press and hold **Continue** until all of the lights cycle to perform the function or to save the value.
- Press and hold **Cancel** until all of the lights cycle to return to the menu item.
- Turn the printer off to exit the menu.

Menu, menu item, and values

Lexmark E260d, E260dn

	Ready/Status	Power/Save	Error	Ready
Press Continue	●	○	○	○
Ready/Status	●	○	○	○
Power/Save	○	●	○	○
Error	○	○	●	○
Ready	○	○	○	●
Print Diag Inst	○	○	○	○
Print Quality Pgs	○	○	○	○
Defaults = U.S.	○	○	○	○
U.S.	○	○	○	○
Europe	○	○	○	○
Edge to Edge = Off	○	○	○	○
Off	○	○	○	○
On	○	○	○	○
Cont Prit Simplex Tray 1	○	○	○	○
Cont Prit Duplex Tray 1	○	○	○	○
Cont Prit Continue Tray 2	○	○	○	○
Cont Prit Duplex Tray 2	○	○	○	○
Par 5 Stroke Adj = 0	○	○	○	○
-4	○	○	○	○
-3	○	○	○	○
-2	○	○	○	○
-1	○	○	○	○
0	○	○	○	○
1	○	○	○	○
Print Event Log	○	○	○	○
Mark History	○	○	○	○
History Mode =	○	○	○	○
Modified Only	○	○	○	○
Every Time	○	○	○	○
Network NVRAM Partition	○	○	○	○
Basic Setup	○	○	○	○
Optra Form = On	○	○	○	○
On	○	○	○	○
Off	○	○	○	○
Midtrack Mode = Yes	○	○	○	○
Yes	○	○	○	○
No	○	○	○	○
IDS = Active	○	○	○	○
Active	○	○	○	○
Deactive	○	○	○	○

● Light On
○ Light Off
○ Light Blinking
○ None

Note: The light sequences change relative to the options on the printer.

Configuration menu selections

To enter the Configuration menu:

1. Turn off the printer.
2. Open the front access door.
3. Turn on the printer while pressing and holding **Continue** ▷ .
4. Close the front access door once the **Error**  light displays.

Print menus by pressing and holding ▷ until all of the lights flash.

Utilities

Use the Utilities menu to troubleshoot printer problems.

Setting	Use setting to	Values
Reset Factory Defaults	Return the printer settings to factory default values. Sometimes resetting the printer to the original settings solves formatting problems. All menu items are reset to the factory default values except: <ul style="list-style-type: none"> • All settings in the Parallel menu, Network menu, and USB menu. • All downloaded resources (fonts, macros, and symbol sets) in printer memory (RAM) are deleted. Resources in flash memory are unaffected.	
Hex Trace	Help isolate printing problems when unexpected characters print or characters are missing. Hex Trace helps determine if there is a problem with the language interpreter or the cable by providing information about what the printer is receiving. To exit Hex Trace, turn off the printer.	Off (default) On
Print Quality Test Pages	Help isolate print quality problems, such as streaking. Four pages print to help evaluate print quality: <ul style="list-style-type: none"> • A text page with printer information, cartridge information, current margin settings, and a graphic. • One page is gray with graphics, one is black, and one is blank. 	
Reset Photoconductor Maintenance Counter	Return the photoconductor counter to zero. The replace photoconductor message should be cleared <i>only</i> when the photoconductor kit has been replaced.	

Setup

Use the Setup menu to configure how the printer formats the end of a line depending on the computer system being used.

Menu item	Use setting to	Values
Demo Mode	Put printer into demo mode where internal sheets print with each press of ▷. To deactivate, turn the printer off, and re-enter configuration group. Set to deactivate.	Deactivate (default) Activate
Auto CR After LF	Specify whether the printer automatically performs a carriage return after a line feed control command.	Off (default) On
Auto LF after CR	Specify whether the printer automatically performs a line feed after a carriage return control command.	Off (default) On
Energy Conserve	When setting is on, the user cannot disable Power Saver. When off, Power Saver will be off.	Off On (default)

Parallel

Use the Parallel menu to change printer settings on jobs sent through a parallel port.

Menu item	Use setting to	Values
NPA Mode	Send print jobs to the printer and query printer status information simultaneously.	Off On Auto (default)
Protocol	Receive information at a much higher transmission rate if the printer is set to Fastbytes (if the computer supports Fastbytes) or receive information at a normal transmission rate if the printer is set to Standard.	Standard Fastbytes (default)
Parallel Mode 2	Determine whether the parallel port data is sampled on the leading (On) or trailing (Off) edge of strobe.	Off On (default)
MAC Binary PS	Configure the printer to process Macintosh binary PostScript print jobs.	Off—The printer filters PostScript print jobs using Standard protocol. On—The printer processes raw binary PostScript print jobs from computers using the Macintosh operating system. This setting often causes Windows print jobs to fail. Auto (default)—The printer processes print jobs from computers using either Windows or Macintosh operating systems.

USB

Use the USB menu to change printer settings on jobs sent through a USB port.

Menu item	Use setting to	Values
NPA Mode	Send print jobs to the printer and query printer status information simultaneously.	Off On Auto (default)
MAC Binary PS	Configure the printer to process Macintosh binary PostScript print jobs.	Off—The printer filters PostScript print jobs using Standard protocol. On—The printer processes raw binary PostScript print jobs from computers using the Macintosh operating system. This setting often causes Windows print jobs to fail. Auto (default)—The printer processes print jobs from computers using either Windows or Macintosh operating systems.

Network

Use the network menu to change printer settings on jobs sent through a network port (either standard network or network opt <x>).

Menu item	Use setting to	Values
NPA Mode	Send print jobs to the printer and query printer status information simultaneously.	Off Auto (default)
MAC Binary PS	Configure the printer to process Macintosh binary PostScript print jobs.	Off—The printer filters PostScript print jobs using Standard protocol. On—The printer processes raw binary PostScript print jobs from computers using the Macintosh operating system. This setting often causes Windows print jobs to fail. Auto (default)—The printer processes print jobs from computers using either Windows or Macintosh operating systems.
Set Card Speed	Automatically detect the connection speed of the network. This setting can be disabled to set the speed manually.	Auto (default)—the printer detects current network speed. 10Mbps, half duplex—forces the printer to try to connect to the network only at 10Mbps, half duplex. 10Mbps, full duplex—forces the printer to try to connect to the network only at 10Mbps, full duplex. 100Mbps, half duplex—forces the printer to try to connect to the network only at 100Mbps, half duplex. 100Mbps, full duplex—forces the printer to try to connect to the network only at 100Mbps, full duplex.

Diagnostics mode selections

To enter the Diagnostics mode:

1. Turn off the printer.
2. Open the front access door.
3. Turn on the printer while pressing and holding **Cancel** X .
4. Close the front access door once the **Error**  light displays.

Print the menu page by pressing and holding **Continue** ▷ until all of the lights flash. Follow the instructions on the menu page to access the menu items shown in the table below.

Menu item	Use setting to	Value
Prt Quality Pgs	Print test pages by pressing and holding ▷ until the lights flash. Help isolate print quality problems, such as streaking. Four pages print: A text page with printer information, cartridge information, current margin settings, and a graphic. Three pages all gray, all black, and the last one blank. Cartridge lockout function is disabled.	None
Edge to Edge	Allow a shift of all four margins (top, bottom, right, and left) to the physical edge of the page (printable area of supported paper). Setting is ignored by PPDS interpreter.	Off (default) On
Defaults	Change sizes and designations to metric.	U.S. (default) Non-U.S.
Cont Prt Simplex Tray 1	Continuously print pages containing cross lines, printer information, and margin settings. Press and hold ▷ until the lights flash to begin. Press X to stop.	None
Cont Prt Duplex Tray 1	Continuously print pages containing cross lines, printer information, and margin settings. Press and hold ▷ until the lights flash to begin. Press X to stop.	None
Cont Prt Simplex Tray 2	Continuously print pages containing cross lines, printer information, and margin settings. Press and hold ▷ until the lights flash to begin. Press X to stop.	None
Cont Prt Duplex Tray 2	Continuously print pages containing cross lines, printer information, and margin settings. Press and hold ▷ until the lights flash to begin. Press X to stop.	None
Print History	Print history of errors. Press and hold ▷ until the lights flash to print.	None
Configuration ID	Allow the printer ID to match the label ID after the controller board is replaced.	000101 (default) 000189
Printer alignment	Align a new printhead. See “Printhead assembly mechanical adjustment” on page 3-9 for more information.	None

Adjustment procedures

Printhead assembly mechanical adjustment

Note: The printhead **must** be aligned electronically. To align the printhead electronically, call the next level of support.

A printhead needs to be correctly positioned after it has been removed. Use a pencil to mark the screw locations of the old printhead on the metal frame. Align the new printhead relative to the location of the old printhead.

Skew is caused by a sheet being fed through the printer while misaligned. The entire image is rotated relative to the sheet edges. However, a mechanically misaligned printhead causes the horizontal lines to appear skewed while the vertical lines remain parallel to the vertical edges. There are no adjustments for skew. Check the pick roll (paper pick assembly) for wear, the paper path for obstructions, the fuser for proper setting, and the tray paper guides for fit to the media.

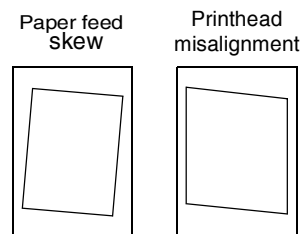

To adjust the printhead:

1. Enter the Diagnostics Menu. See **“Diagnostics mode selections” on page 3-8**.
2. Press and release **X** to go to Cont Prt Simplex Tray 1 ( is on).
3. Press and hold **▷** to print the first Cont Prt Simplex Tray 1 test page. Press **X** immediately after the paper picks to avoid printing more pages.
4. Fold the printed test page on the left side so that a few millimeters of grid lines wrap around the outside of the fold. See photo below.
5. Fold a second vertical fold near the center so that the left side top edge aligns with the right side top edge.



6. If the grid lines of the right flap align below the corresponding lines on the left flap, then adjust the printhead clockwise relative to the printer and recheck. (See the left side of the figure below.) If the grid lines of the left flap align below the corresponding lines of the right side, then adjust the printhead counterclockwise. (See the right side of the figure below.)

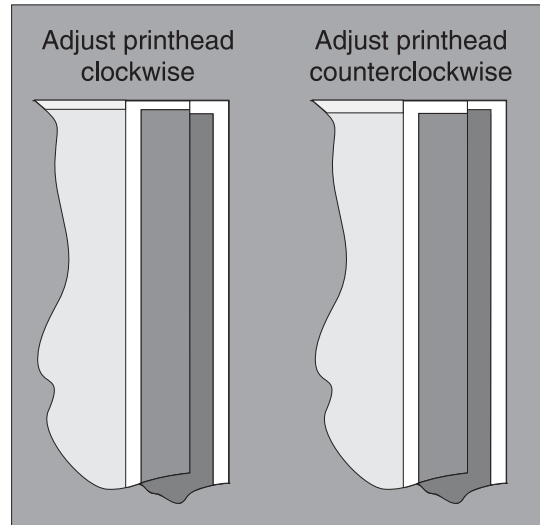

7. After obtaining a properly adjusted image on the paper, tighten all three screws.

4. Repair information

Warning: Read the following before handling electronic parts.

Handling ESD-sensitive parts

Many electronic products use parts that are known to be sensitive to electrostatic discharge (ESD). To prevent damage to ESD-sensitive parts, follow the instructions below in addition to all the usual precautions, such as turning off power before removing logic cards:

- Keep the ESD-sensitive part in its original shipping container (a special “ESD bag”) until the part is ready to be installed into the printer.
- Make the least-possible body movements to prevent an increase of static electricity from clothing fibers, carpets, and furniture.
- Put the ESD wrist strap on your wrist. Connect the wrist band to the system ground point. This discharges any static electricity in your body to the printer.
- Hold the ESD-sensitive part by its edge connector shroud (cover); do not touch its pins. If a pluggable module is being removed, then use the correct tool.
- Do not place the ESD-sensitive part on the MFP cover or on a metal table; if the ESD-sensitive part needs to be put down for any reason, then first put it into its special bag.
- Machine covers and metal tables are electrical grounds. They increase the risk of damage because they make a discharge path from your body through the ESD-sensitive part. (Large metal objects can be discharge paths without being grounded.)
- Prevent ESD-sensitive parts from being accidentally touched by other personnel. Install machine covers when the machine is not being worked on, and do not put unprotected ESD-sensitive parts on a table.
- If possible, keep all ESD-sensitive parts in a grounded metal cabinet (case).
- Be extra careful in working with ESD-sensitive parts when cold-weather heating is used, because low humidity increases static electricity.

Removal procedures

Note:

- Remove the toner cartridge and media tray before removing other printer parts. The toner cartridge should be protected from light while out of the printer.
- Disconnect all external cables from the printer to prevent damage during service.
- Unless otherwise stated, reinstall the parts in reverse order of removal.
- When reinstalling a part held with several screws, start all screws before final tightening.
- Remove the paper tray and print cartridge before proceeding with a removal.



ACM pick tire roller removal

1. Place the printer on its side.

Note: Be careful to not mar the finish of the printer.

2. Open the duplex jam door just far enough to pull out the ACM pick tires.

Warning: Open the duplex door only far enough to remove the ACM pick tires. If the door is opened too far, then it can become disengaged and interfere with the paper tray. The tray may go in but will not come out, and will render the printer as non-serviceable.

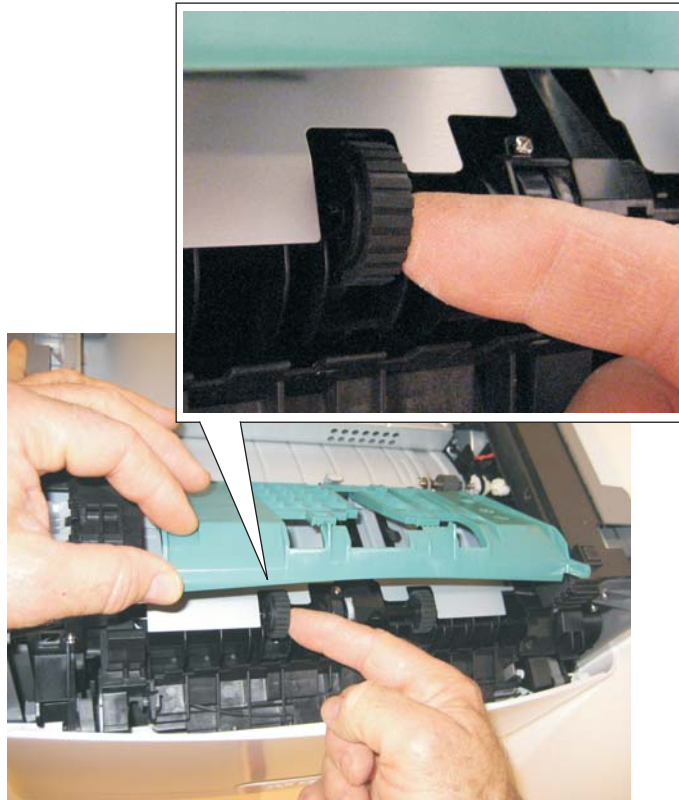

3. After the ACM pick tires have been pulled out, close the duplex door.

4. Remove the ACM pick tire roller (A).

Note:

- If the left hub is gray, then disconnect the old right and left tire/hub assemblies from the ACM, and replace with the new right and left tire/hub assemblies.
- If the left hub is black, then remove the old right and left tires from the ACM hubs, and replace with the new tires. Do not attempt to remove the hubs.

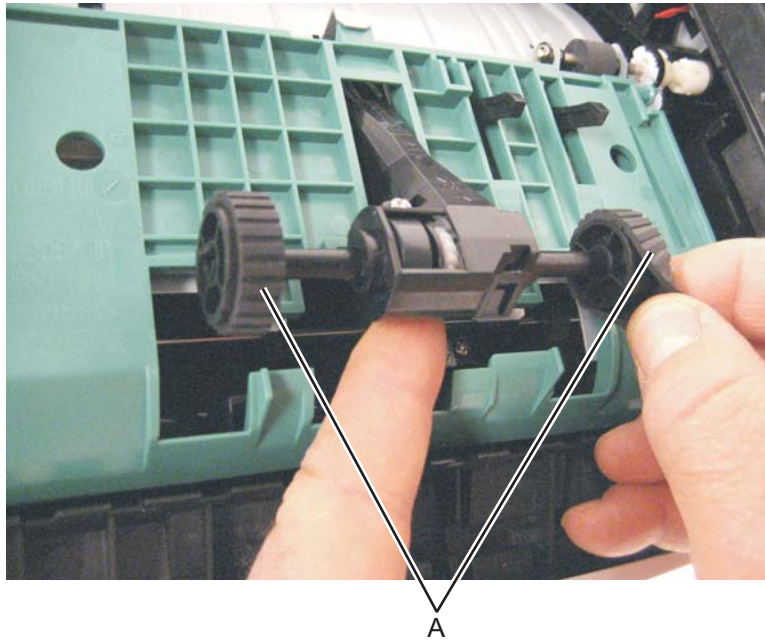

Bezel removal

1. Open the front access door.
2. Flex the top of the bezel, and disconnect the latch (A) from the upper front cover.



A

3. Disconnect the latches (B) from the upper front cover.

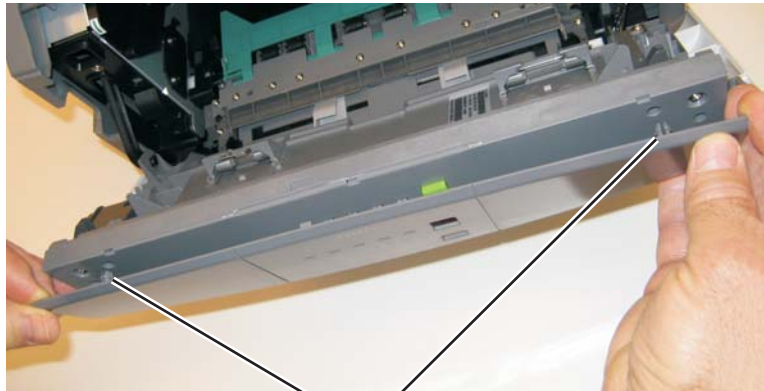

B

4. Remove the bezel.

Controller board removal

Warning:

- Always touch a ground before touching the board.
 - Handle the board carefully by the edges.
 - Never replace the operator panel and controller board without a successful POR in between.
 - Never replace the operator panel and the controller board at the same time. Each card contains the printer settings. When either of these cards is new, it obtains its settings from the other card. Critical factory settings are lost when both cards are new and are replaced at the same time.
1. Remove the right side cover. See **“Right side cover assembly removal” on page 4-51**.
 2. Remove the three screws (A) from the USB port.

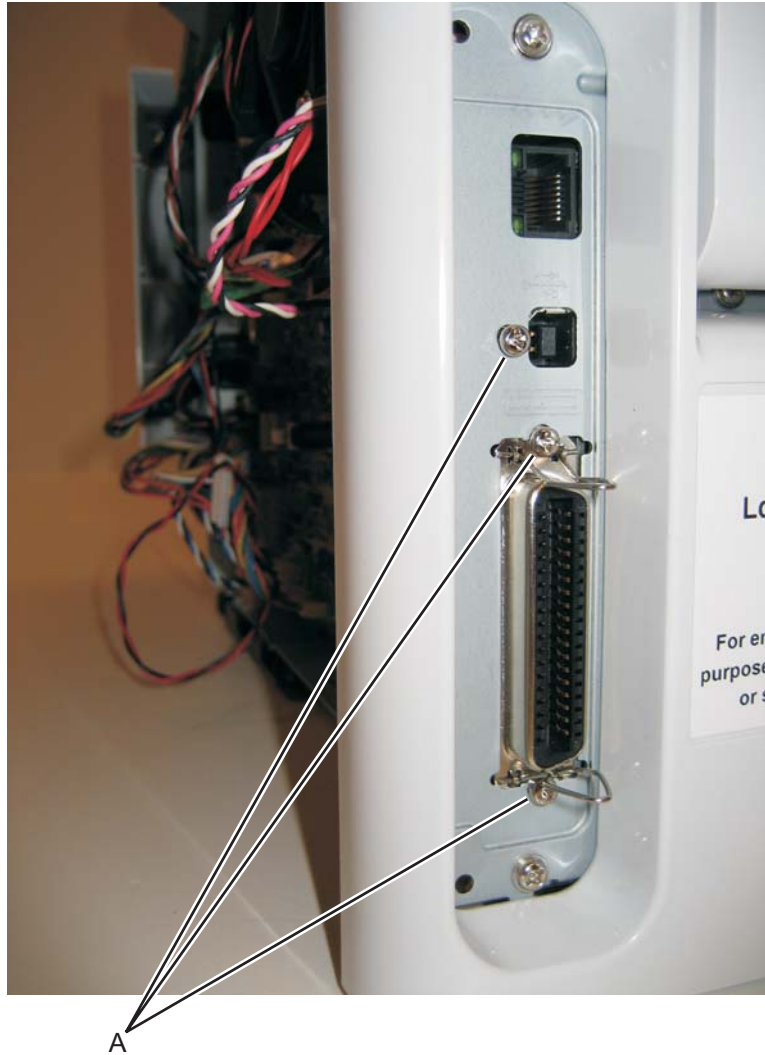

3. Disconnect all of the cables from the controller board.

Note: A drip guard (B) has been added below the controller board. The drip guard may need to be removed to access to the controller board.

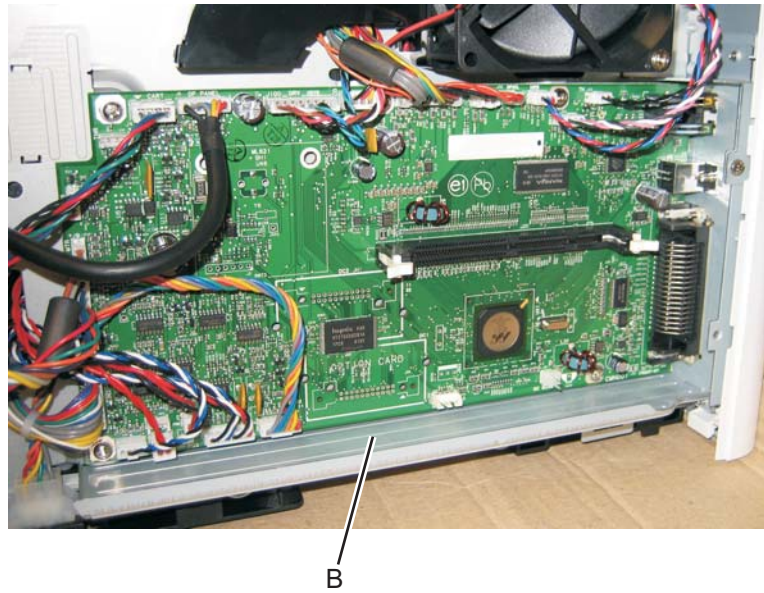

4. Remove the five screws (C) from the controller board.

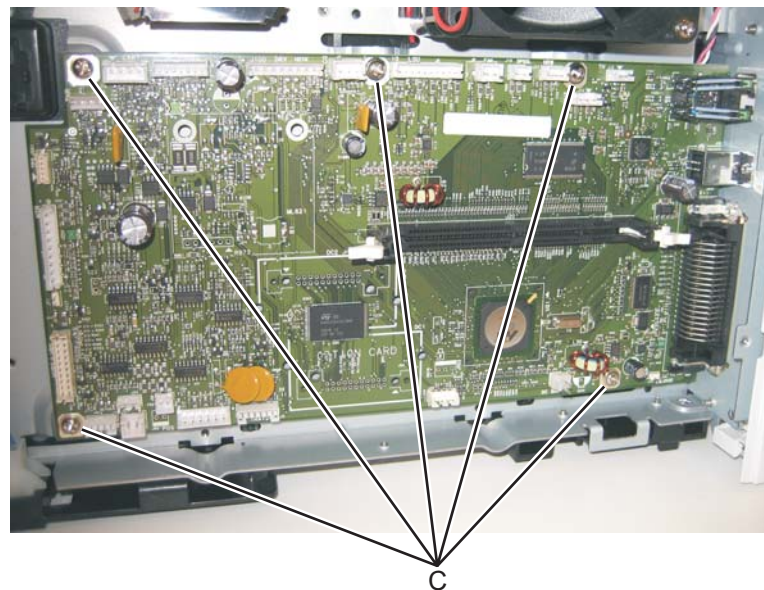

5. Lift the controller board, and remove.

Note: When installing the controller board, place the USB port and parallel port screws first, and then place the controller board screws.

Cover open sensor

1. Remove the right side cover. See **“Right side cover assembly removal”** on page 4-51.
2. Disconnect the cable (A) from the controller board.
3. Use a #1 Phillips screwdriver to remove the screw (B) holding the sensor.

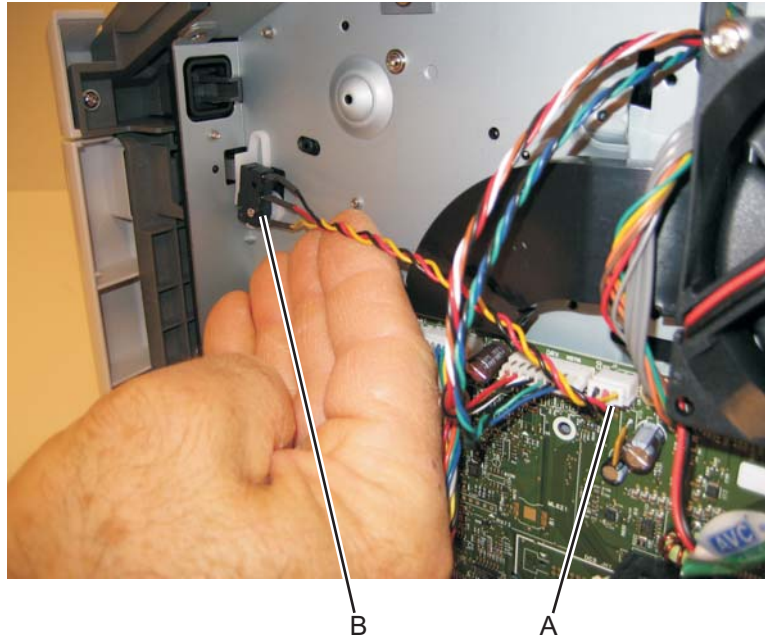

4. Remove the cover open sensor.

Door mount removal

1. Open the front cover.
2. Remove the lower front cover. See **“Lower front cover removal” on page 4-25.**
3. Remove the left side cover. See **“Left side cover removal” on page 4-23**
4. Remove the right side cover. See **“Right side cover assembly removal” on page 4-51.**
5. Disconnect the operator panel cable (A).

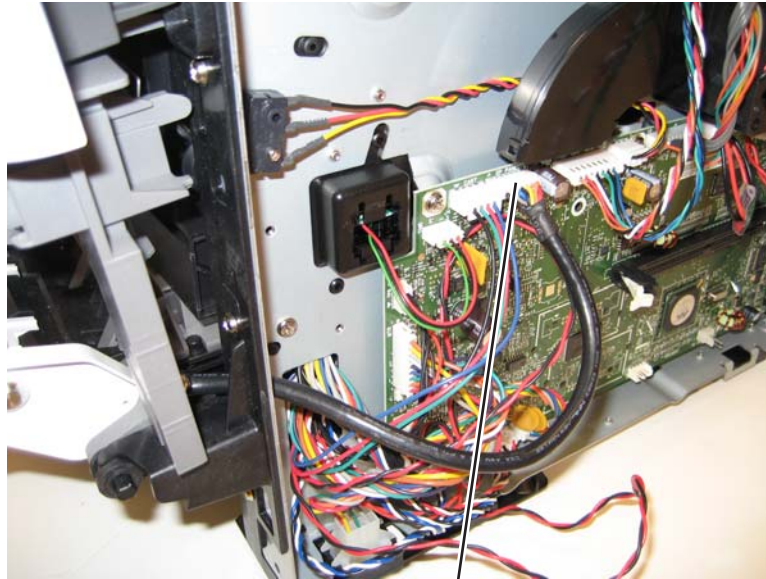

6. Remove the cable through the opening.
7. Remove the three screws (B) from the right side of the printer.

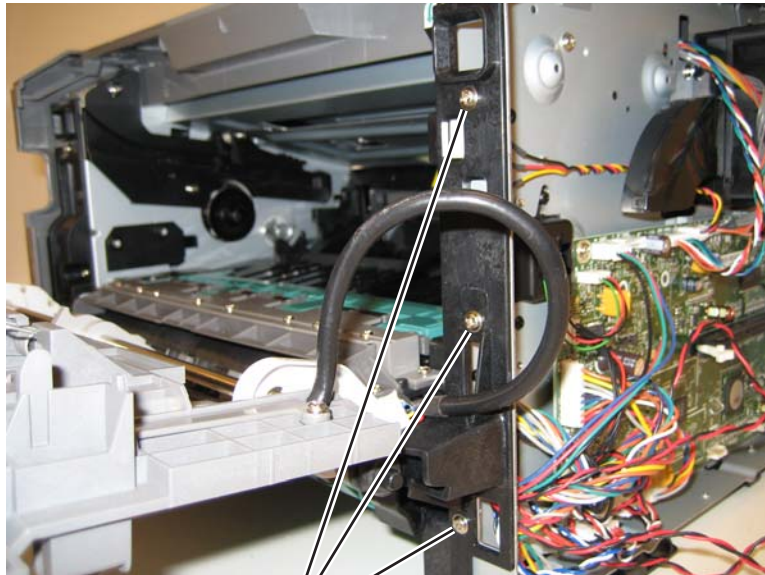

8. Disconnect the fuser link (C).

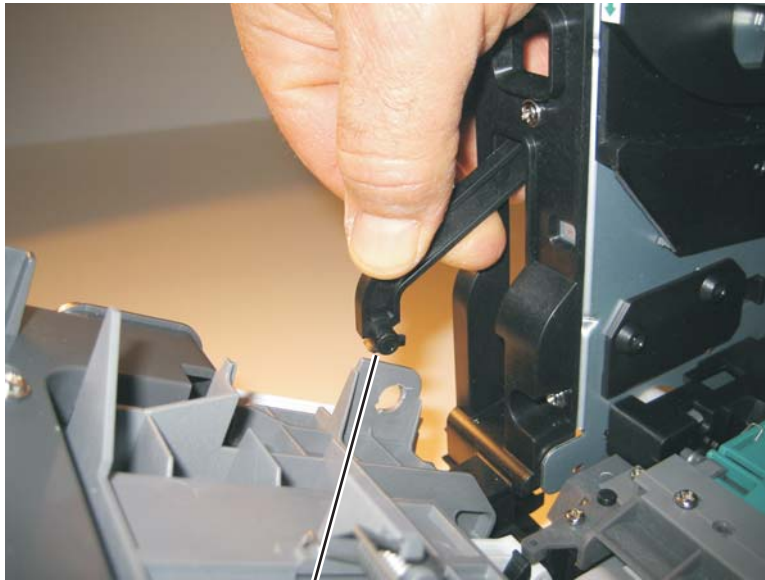

C

9. Remove the three screws (D) from the left side of the printer.



D

10. Remove the door mounts.

Duplex removal

1. Remove the left side cover. See **“Left side cover removal” on page 4-23.**
2. Remove the rear door and rear cover. See **“Rear door and rear cover removal” on page 4-47.**
3. Place the printer on its top.

Note: Be careful to not mar the finish of the printer.

4. Remove the LVPS/HVPS. See **“LVPS/HVPS removal” on page 4-26.**
5. Remove the three screws (A) from the shield.

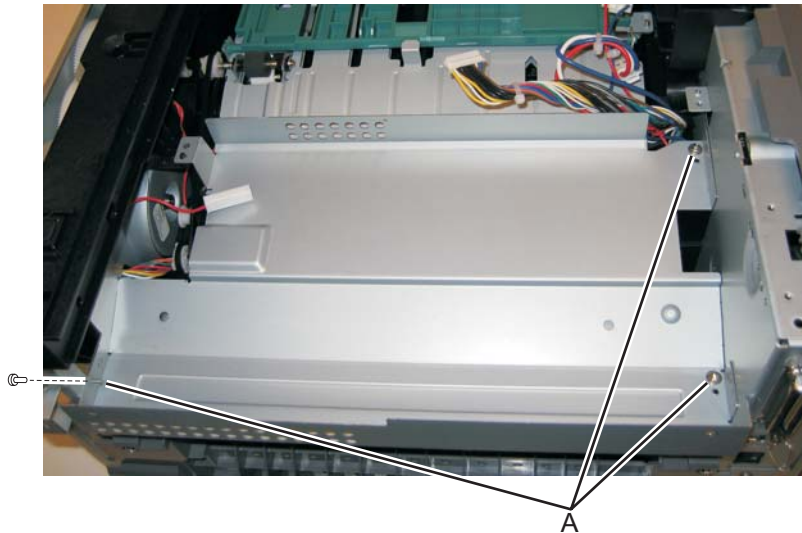

6. Remove the four screws (B) from the duplex.

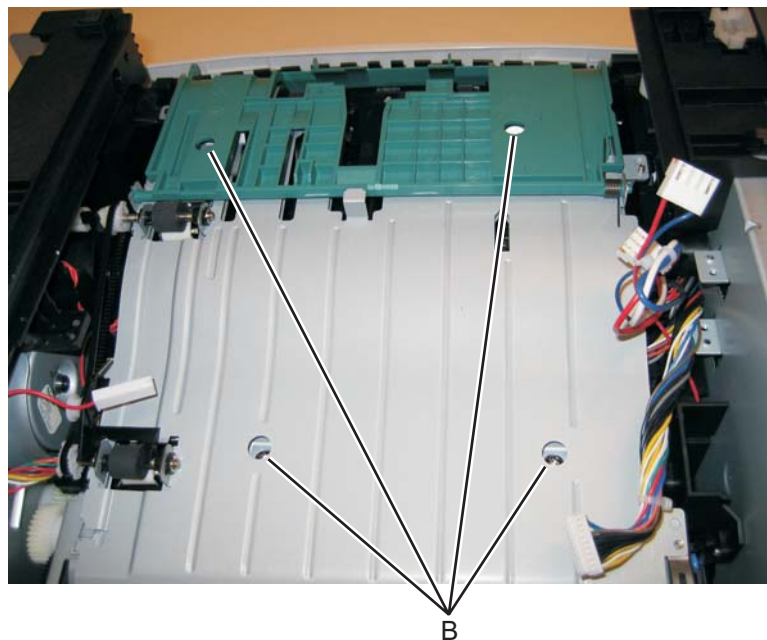

7. Lift the duplex slightly, push to the left, and tilt to clear the right side of the printer.

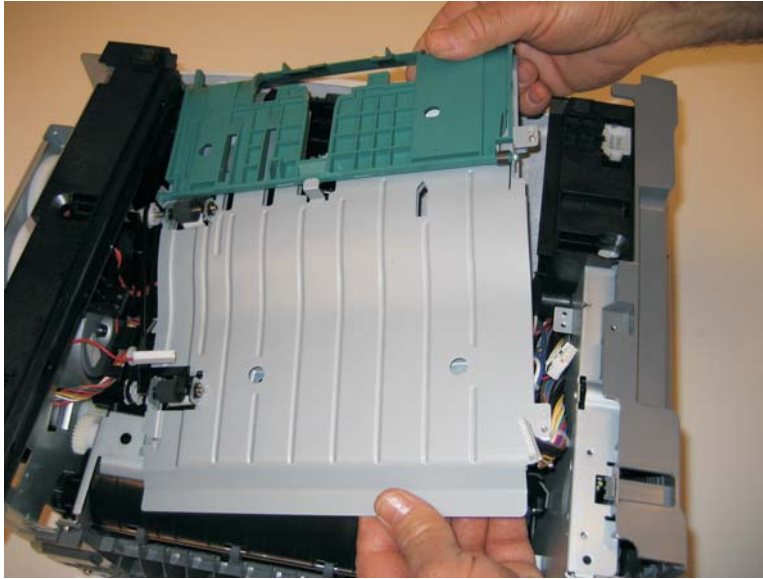

8. Remove the duplex.

Duplex/main motor gear drive interface removal

1. Remove the left side cover. See **“Left side cover removal”** on page 4-23.
2. Remove the LVPS/HVPS. See **“LVPS/HVPS removal”** on page 4-26.
3. Remove the duplex. See **“Duplex removal”** on page 4-11.
4. Remove the main motor gear drive. See **“Main motor gear drive removal”** on page 4-29
5. Remove the e-clip (A) from the gear.

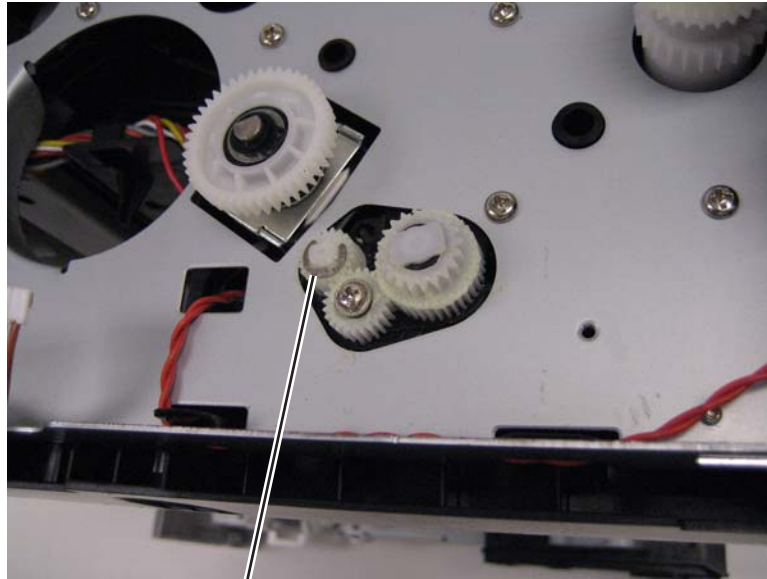

A

6. Remove the gear (B) and gear shaft (C).

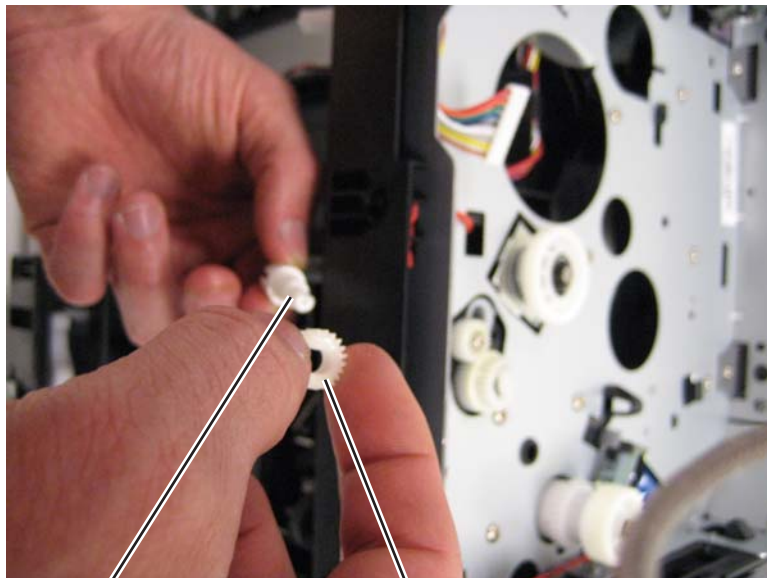

C

B

7. Remove the screw (D) from the gear (E).

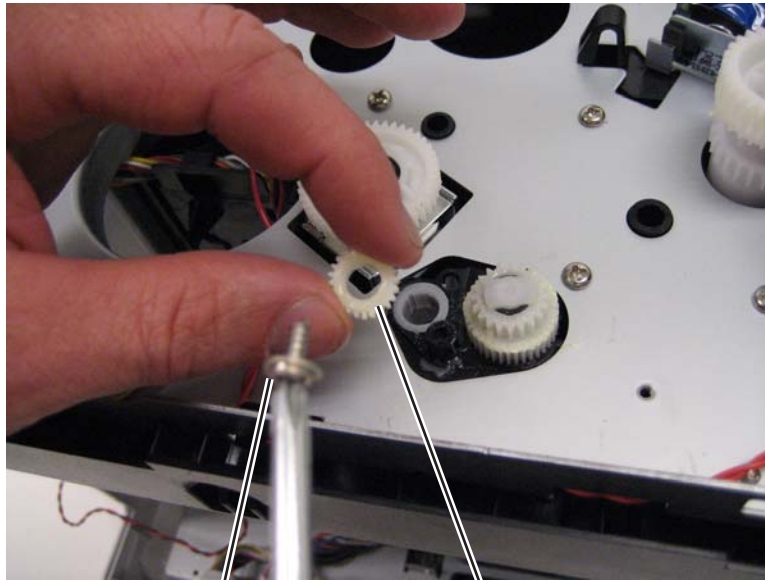

D

E

8. Remove the plastic bushing (F).

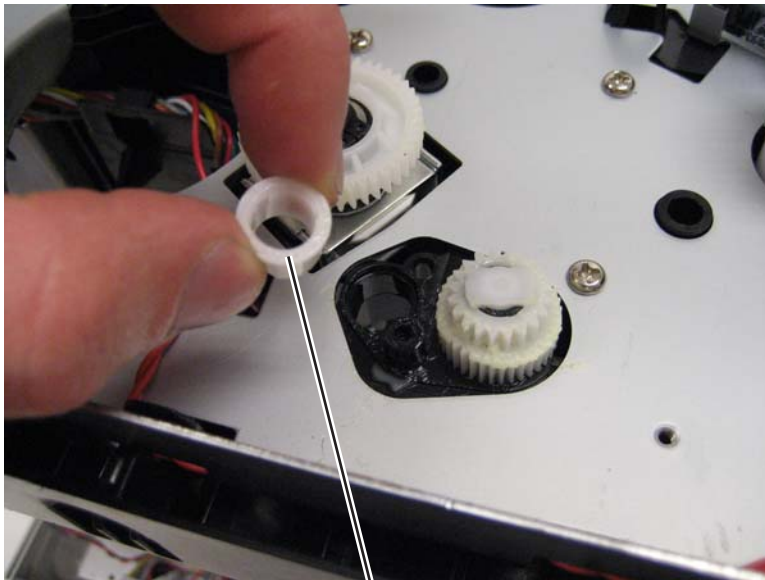

F

9. Use a screwdriver to pop the retainer clip (G) loose from the gear.

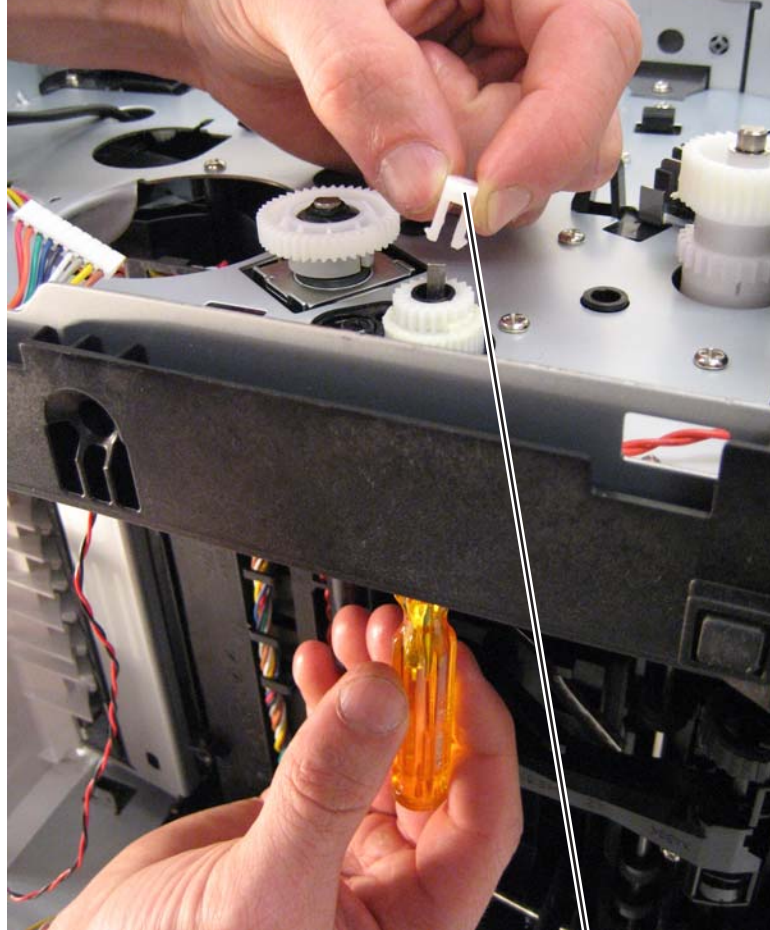

G

10. Remove the gear (H).

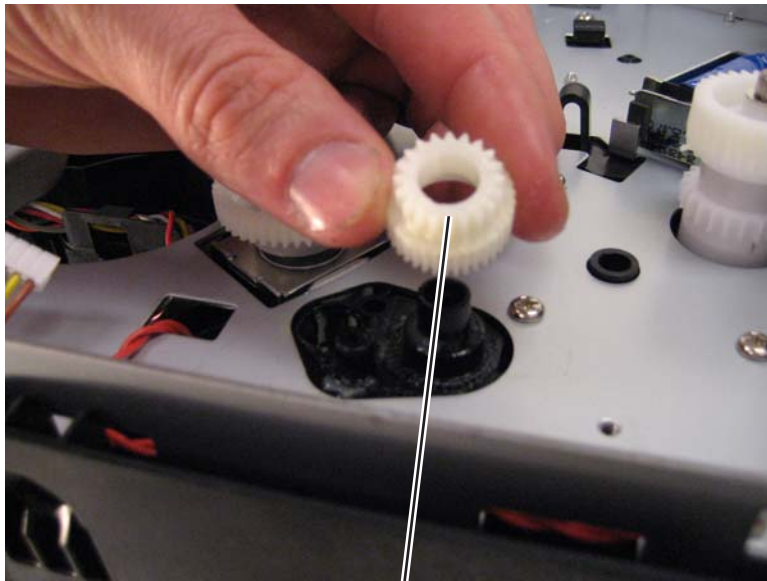

H

Fan removal

1. Remove the right side cover. See **“Right side cover assembly removal” on page 4-51**.
2. Disconnect the cable (A) from the controller board, and remove the two screws (B) holding the fan to the right side frame.

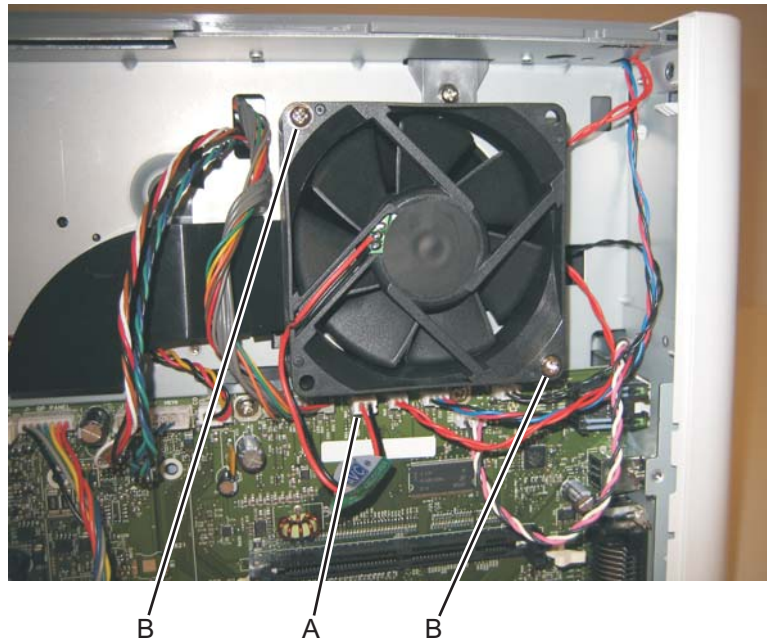

3. Remove the fan.

Front access door removal

1. Remove the operator panel. See **“Operator panel removal”** on page 4-44.
2. Remove the left side cover. See **“Left side cover removal”** on page 4-23.
3. Close the front access door.
4. While closing the MPF cover, pull up on the MPF by the steel shaft until the MPF lifts from its hinges.

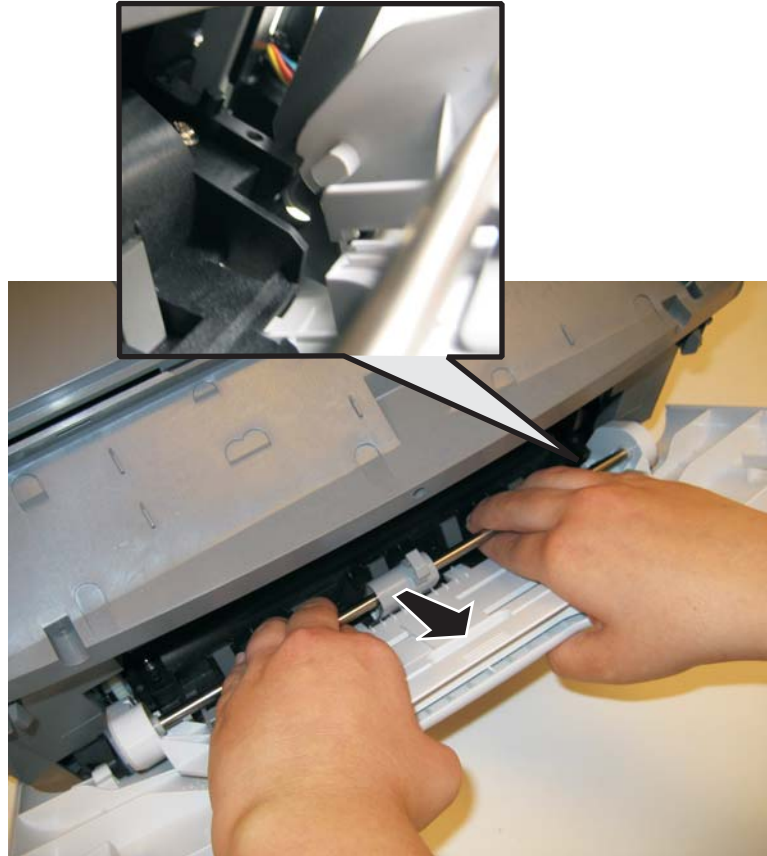

5. Disconnect the MPF from the lower front cover.

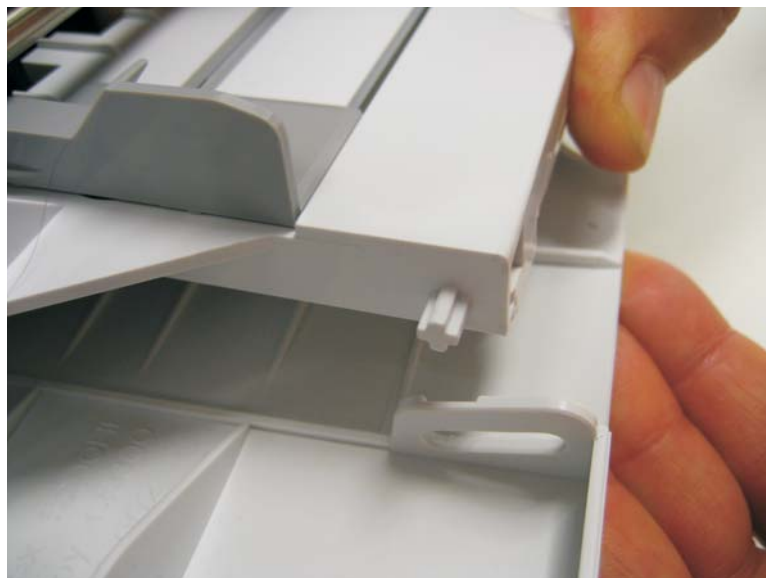

6. Disconnect the fuser link (A) from the front access door.

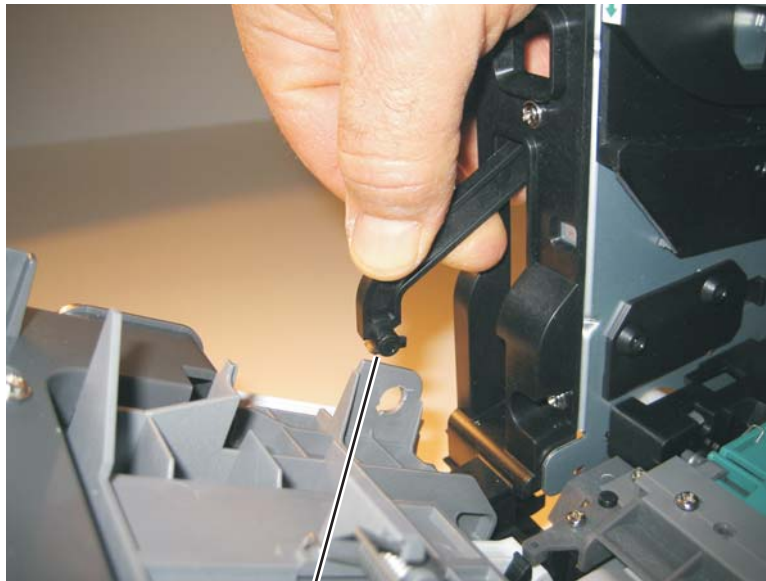

A

7. Disconnect the front access door cable (B), and pull it through the opening to clear the side frame.

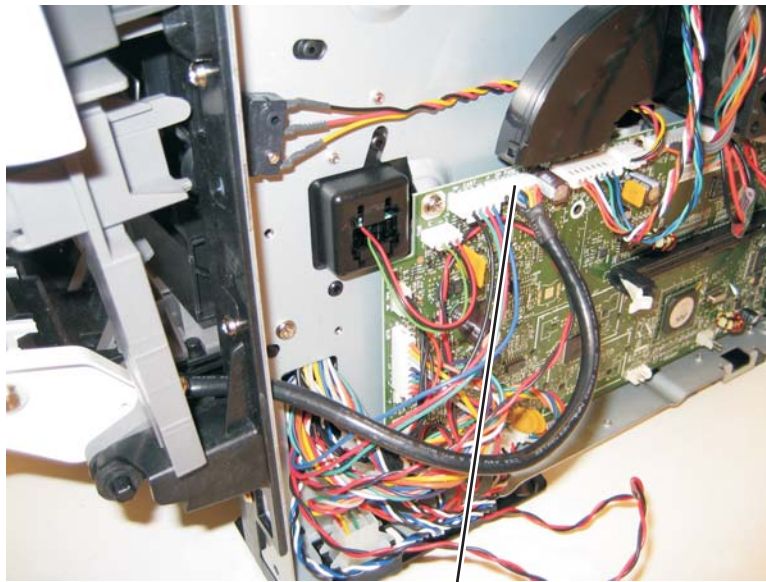

B

8. Disconnect the front access door from its hinges, and remove.

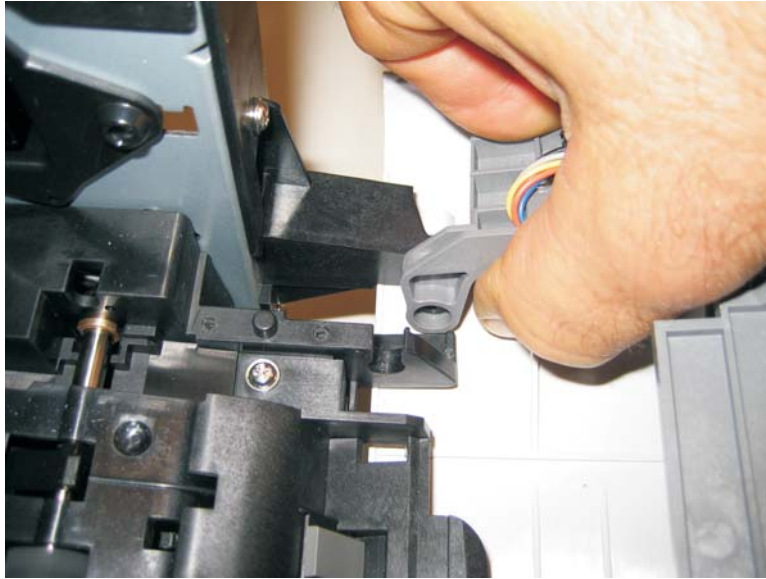

Fuser removal



1. Remove the rear exit guide. See **“Rear exit guide assembly with sensor and reversing solenoid removal” on page 4-49.**
2. Remove the two screws (A).

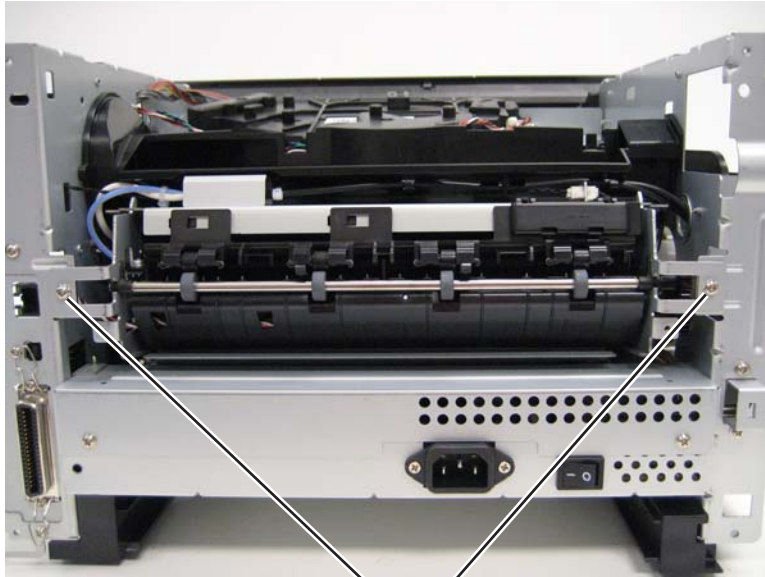

A

3. Partially pull the fuser forward for better access.

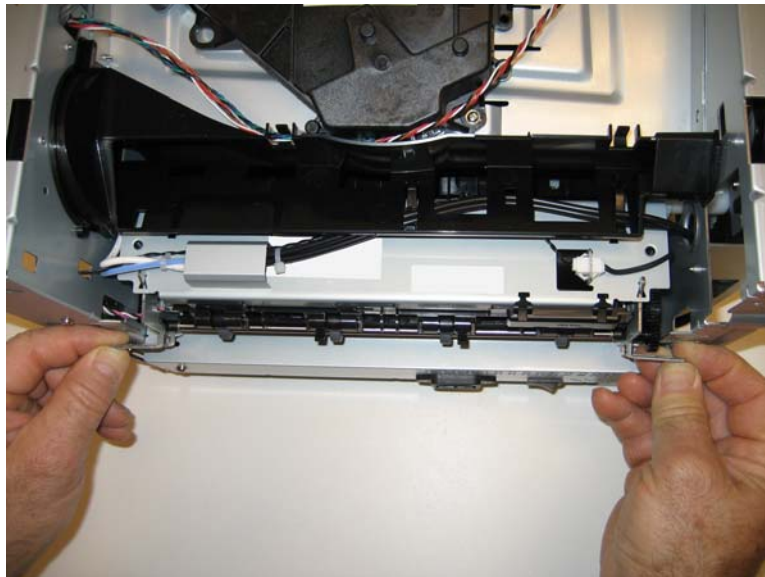

4. Push in on the cable connector cover (B), and remove.

5. Disconnect the AC cable (C).

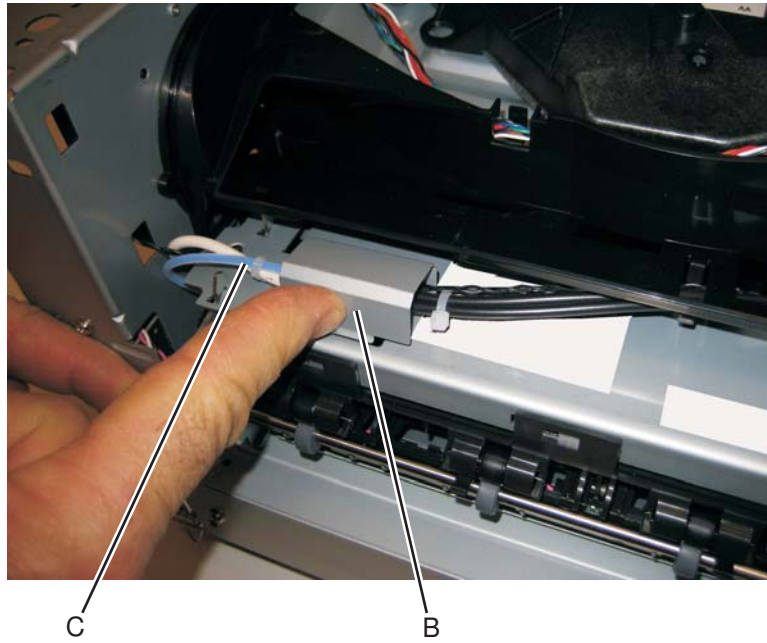

6. Disconnect the thermistor cable (D).

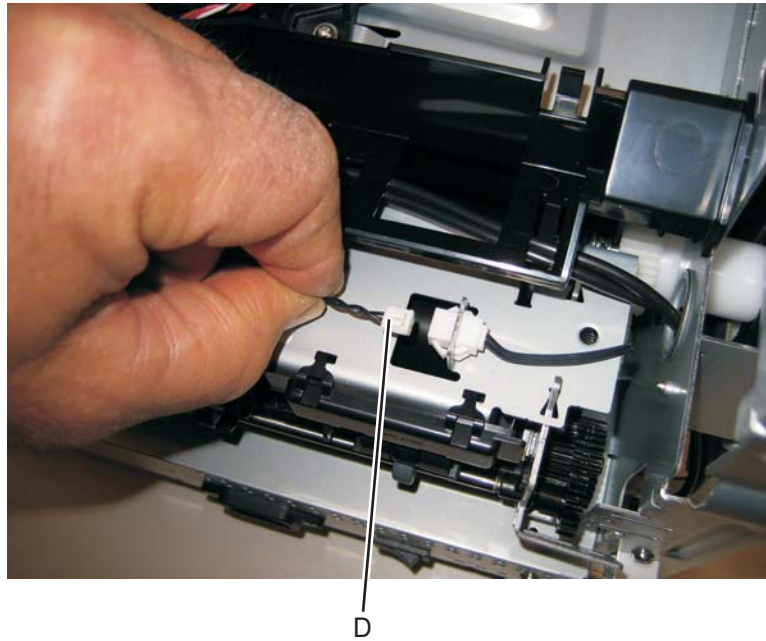

7. Disconnect the exit sensor cable (E) from the controller board.

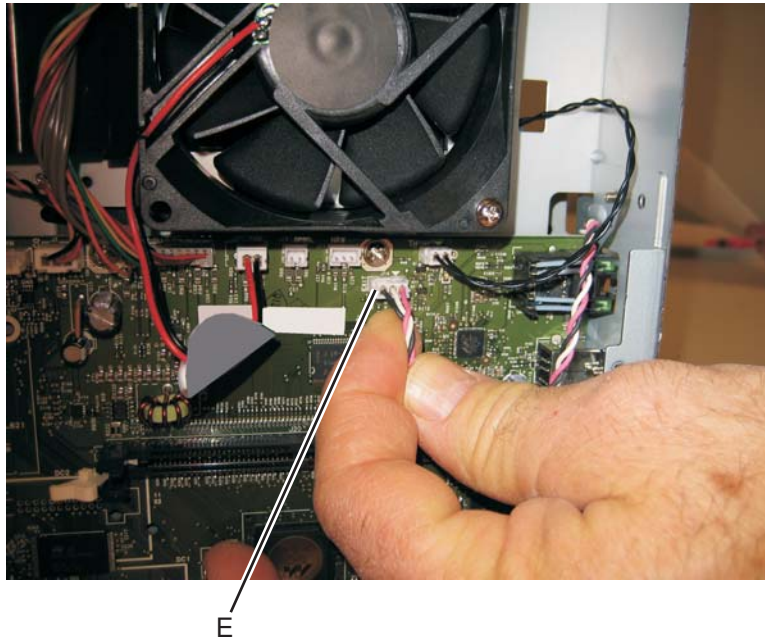

8. Remove the fuser.

Note:

- Be careful to not damage the gears during the fuser installation.
- Be sure to reinstall the AC cable during the fuser installation.

Left side cover removal

Note:

- Leave the front door closed when removing the left side cover.
 - Make sure that the fuser cables are out of the way when removing the left side cover.
1. Remove the paper tray.
 2. Remove the screw (A) from the rear left side of the printer.

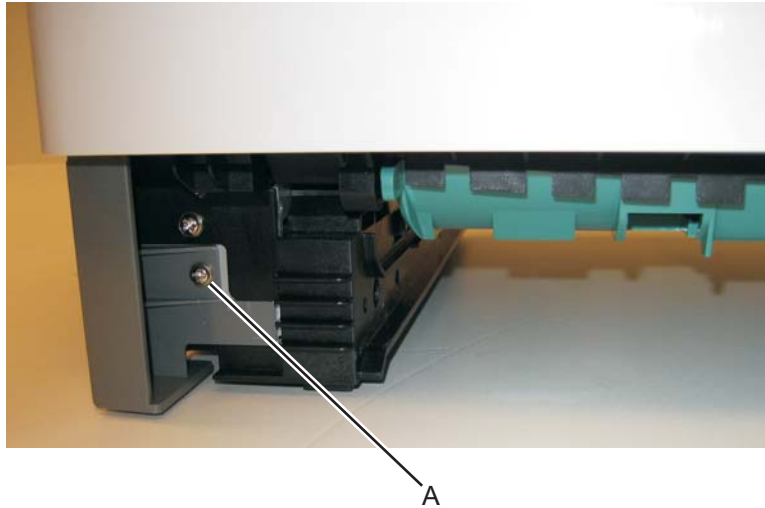

3. Remove the screw (B) and press the two latches (C) on the bottom of the left side cover.

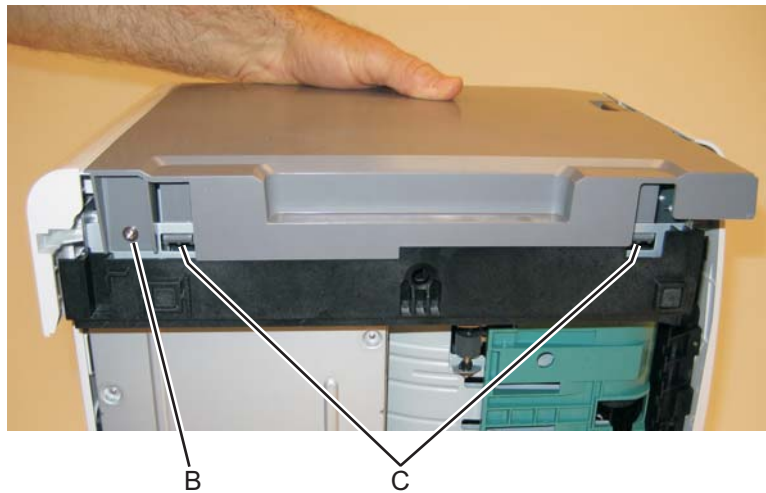

4. Rotate the cover out, and remove the left side cover.

Note: There are two tabs on the top of the left side cover. Do not swing the left side cover open too far, or the tabs will be damaged.



Lower front cover removal

1. Open the lower front cover.
2. Disconnect the manual feed plate notch (A) from the lower front cover.

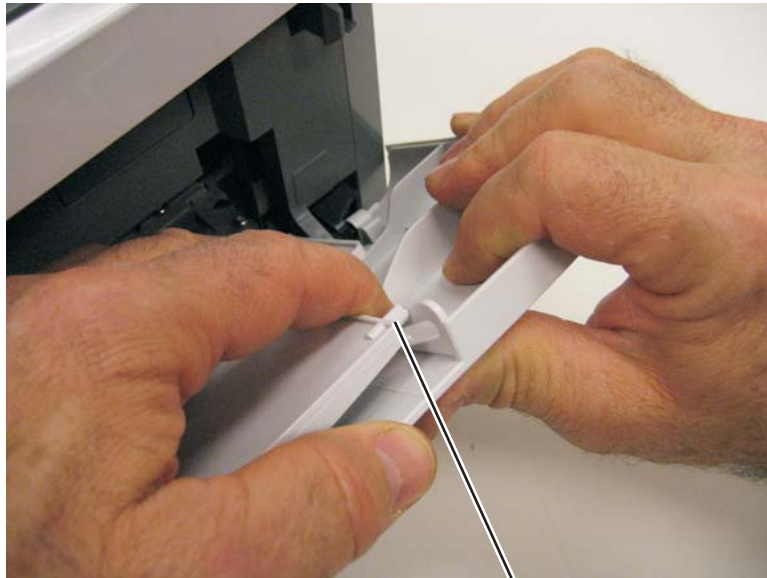

3. Disconnect the lower front cover notches (B) from the front of the printer.



4. Remove the lower front cover.

LVPS/HVPS removal



1. Remove the rear door cover. See **“Rear door and rear cover removal”** on page 4-47.
2. Remove the left side cover. See **“Left side cover removal”** on page 4-23.
3. Place the printer on its top with the rear facing you.

Note: Be careful to not mar the finish of the printer.

4. Remove the two screws (A) from the right rear foot assembly.

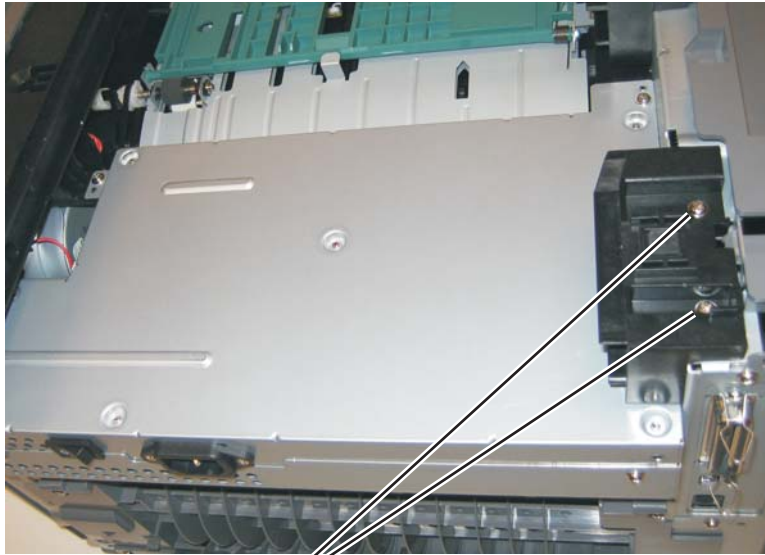

A

5. Disconnect the fuser power cable (B).



B

6. Remove the four screws (C) from the LVPS/HVPS shield.

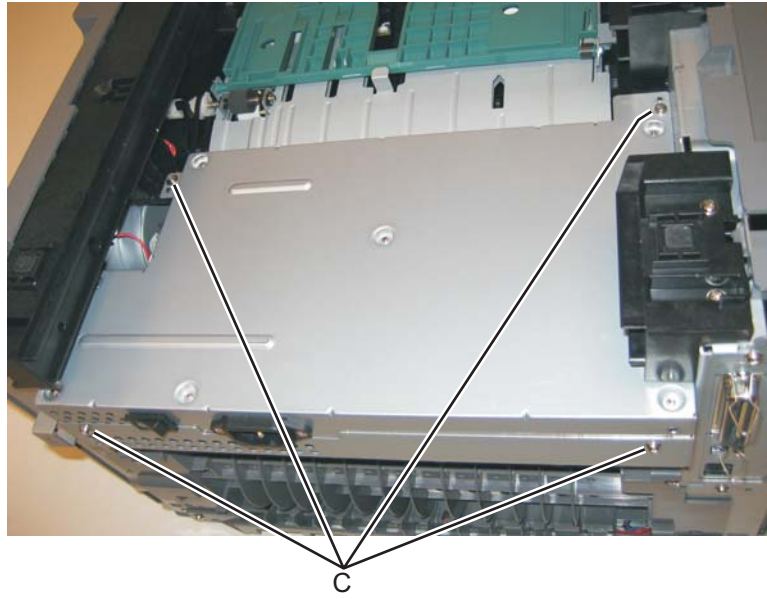

7. Lift the LVPS/HVPS, and disconnect the three cables (D).

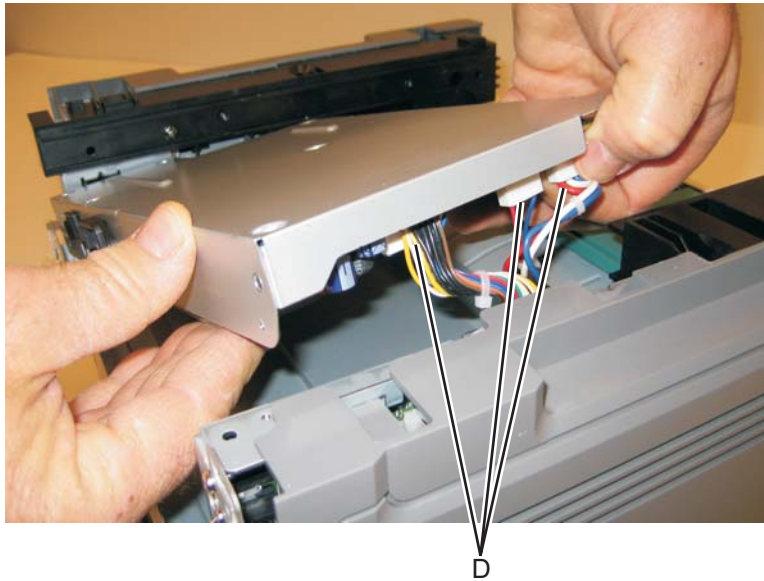

Note: Squeeze the clip to remove the cables from their connectors (E).

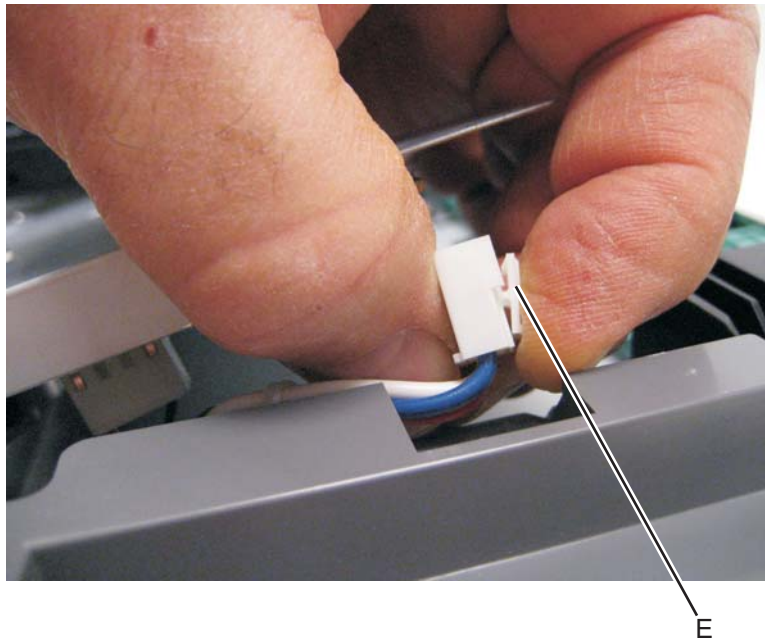

8. Disconnect the transfer roll cable (F).

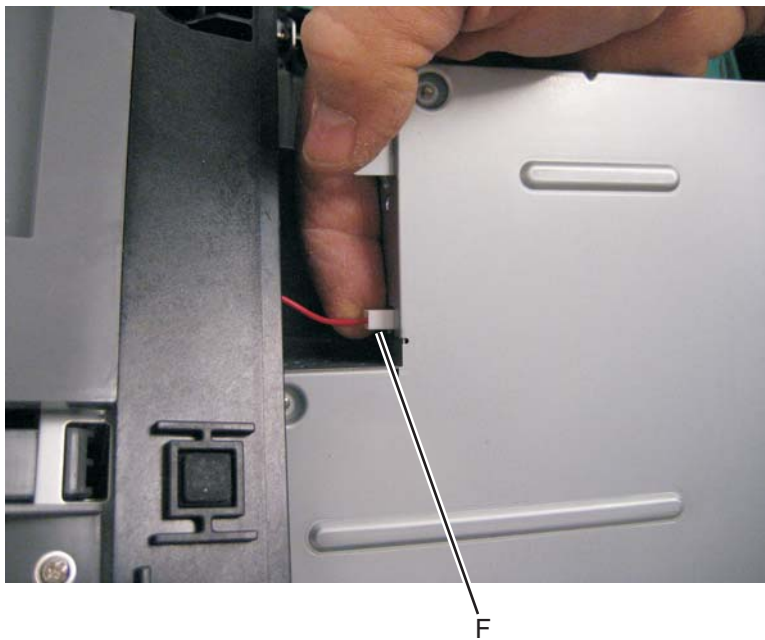

9. Lift and remove the LVPS/HVPS.

Main motor gear drive removal

1. Remove the left side cover. See **“Left side cover removal”** on page 4-23.
2. Open the front access door, and disconnect the fuser link (A).

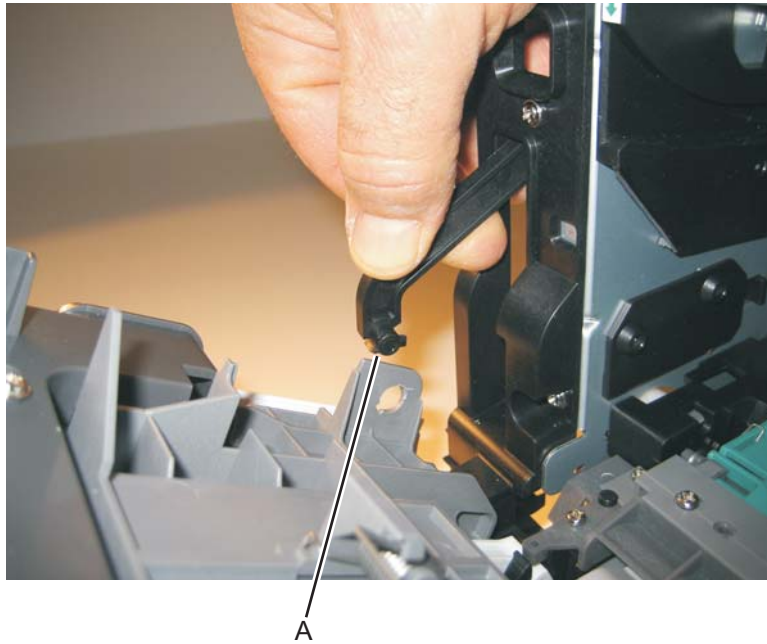

3. Place the printer on its right side.

Note: Be careful to not mar the finish of the printer.

4. Remove the four screws (B) from the main motor gear drive.

Note: The picture below shows the E360d, E360dn printer. The main motor gear drive removal is the same for all models.

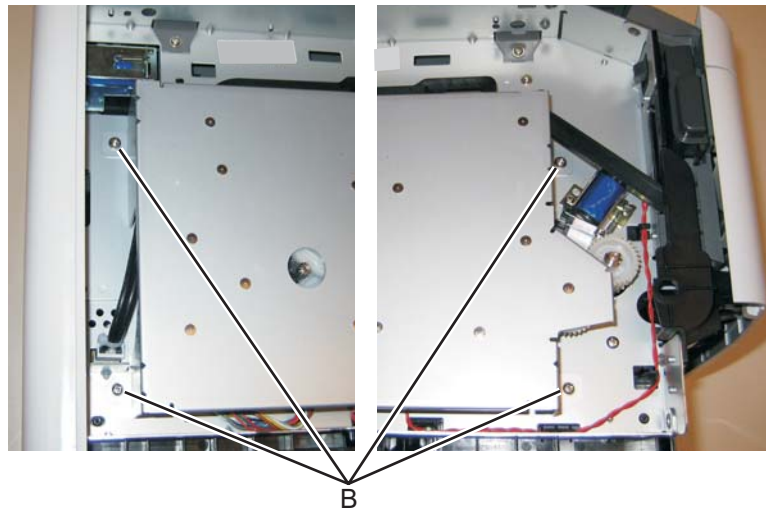

5. Lift the gear drive, and disconnect the main motor gear drive cable (C).

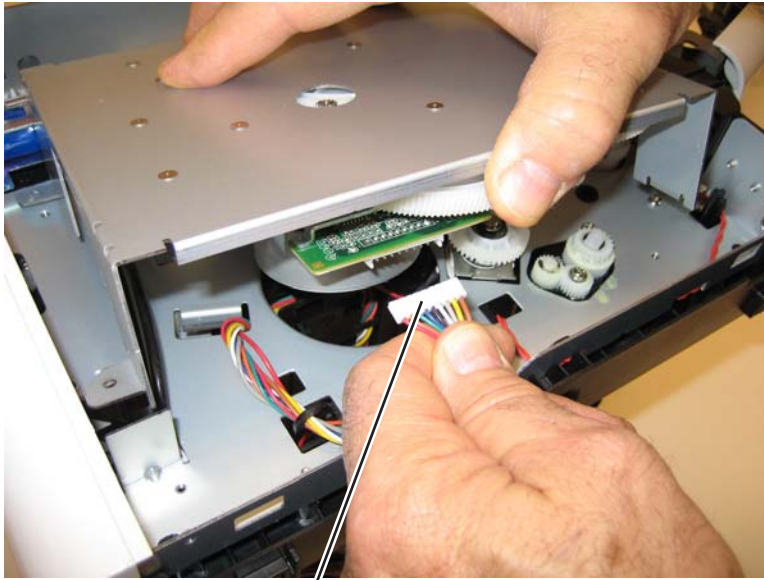

C

6. Remove the main motor gear drive.

Manual feed clutch removal

1. Remove the left side cover. See **“Left side cover removal”** on page 4-23.
2. Open the front access door, and disconnect the fuser link (A).

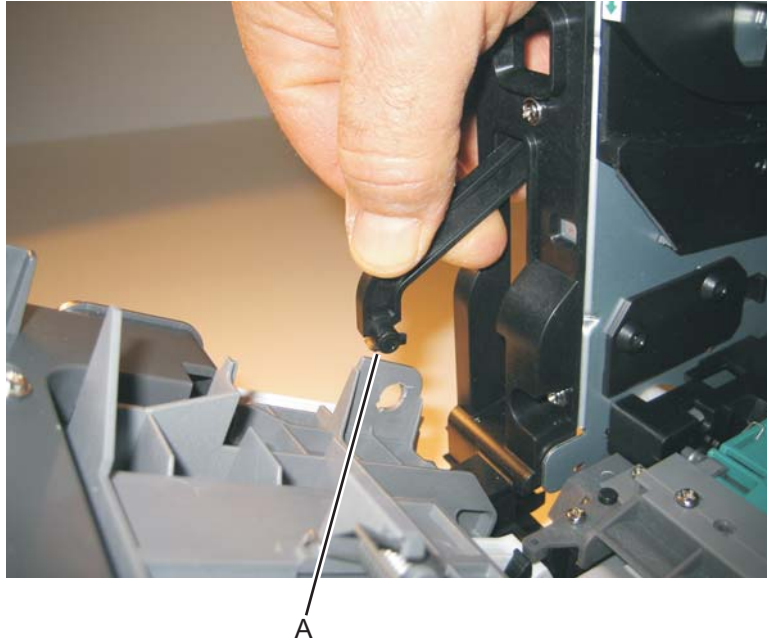

3. Close the front access door, and place the printer on its right side.
- Note:** Be careful to not mar the finish of the printer.
4. Remove the four screws (B) from the main motor gear drive.

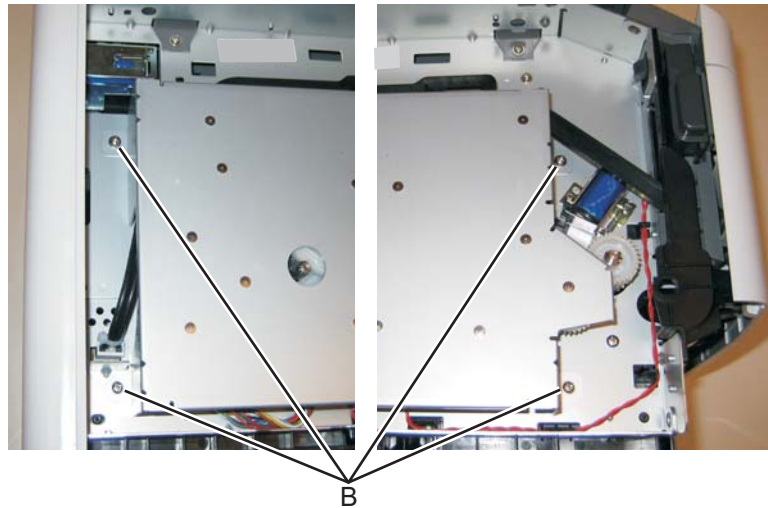

5. Rotate the main motor gear drive enough to access the manual feed solenoid.

6. Use a screwdriver to remove the e-clip (C) from the manual feed clutch.

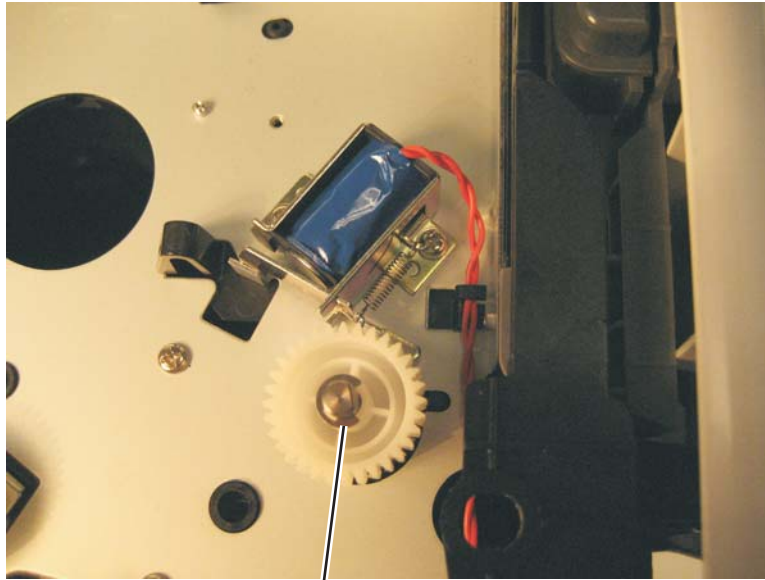

C

7. Remove the manual feed clutch (D).

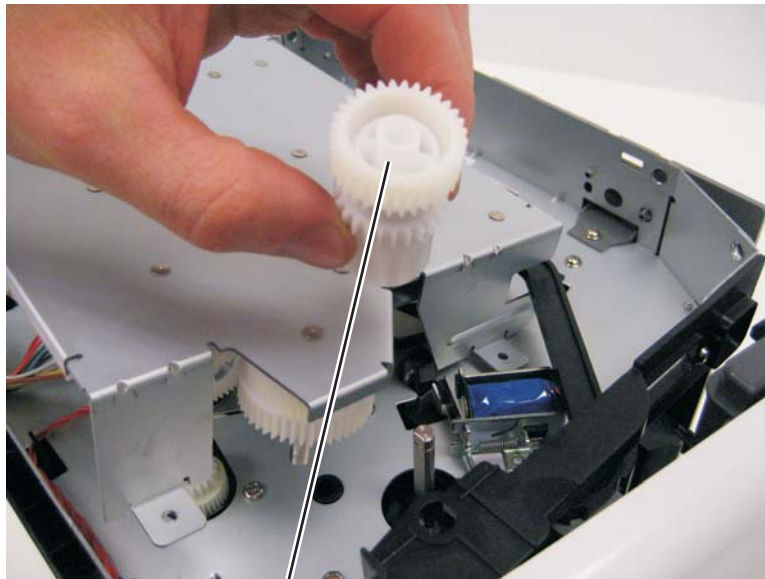

D

1. Remove the left side cover. See **“Left side cover removal”** on page 4-23.
2. Remove the duplex. See **“Duplex removal”** on page 4-11.
3. Open the front access door, and place the printer on its right side.

Note: Be careful to not mar the finish of the printer.

4. Remove the two screws (A).

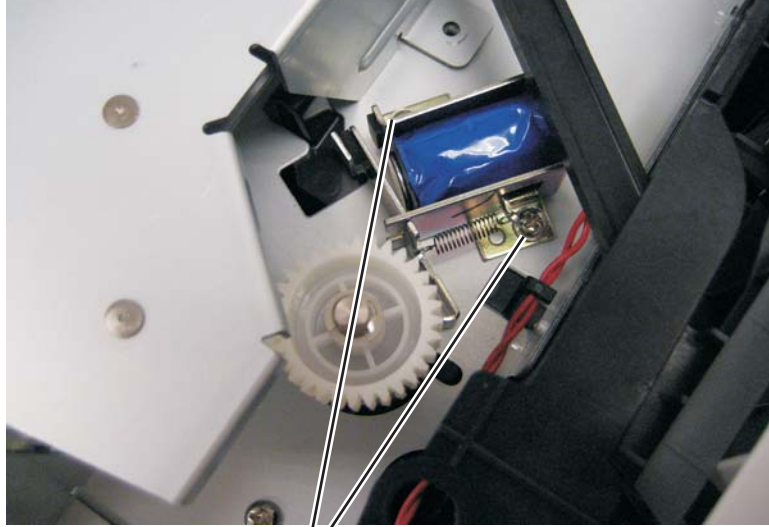

A

5. Remove the three screws (B) from the left door mount.



B

6. Lift and remove the left door mount (C) away from the side frame, and unrout the cable (D) with a spring hook.
7. Reinstall the left door mount, and place the printer on it's top.

Note: Be careful to not mar the finish of the printer.

8. Disconnect the cable (D) from J25 on the controller board.

Installation note:

- Install the two screws holding the new solenoid in place, and route the cable (D) behind the MPF clutch (E).
- After disconnecting the old solenoid cable, connect the new solenoid cable to J25 on the controller board.

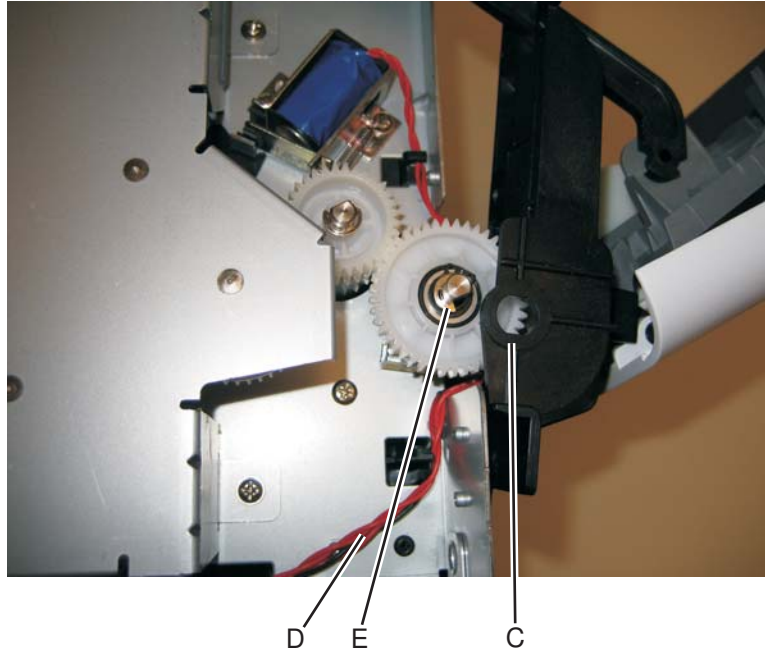

Media ACM ASM feeder removal

1. Remove the left side cover. See **“Left side cover removal”** on page 4-23.
2. Remove the LVPS/HVPS. See **“LVPS/HVPS removal”** on page 4-26.
3. Remove the duplex. See **“Duplex removal”** on page 4-11.
4. Remove the main motor gear drive. See **“Main motor gear drive removal”** on page 4-29.
5. Remove the media feed clutch. See **“Remove the media ACM ASM feeder.”** on page 4-37.
6. Use a screwdriver to pop the shaft retainer tab (A) loose from the ACM feed shaft.

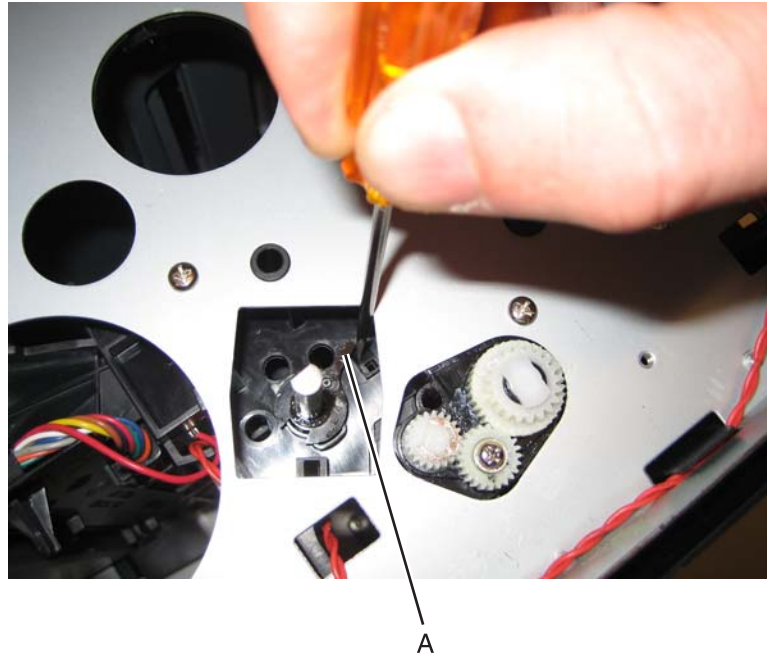

7. Use a small pair of pliers to remove the shaft retainer tab.

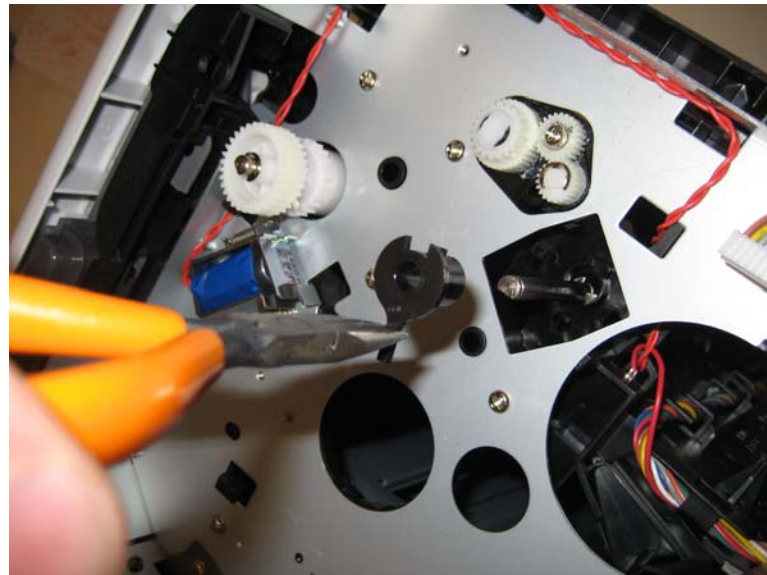

8. Use a screwdriver to pop the inner shaft lock (B) loose.

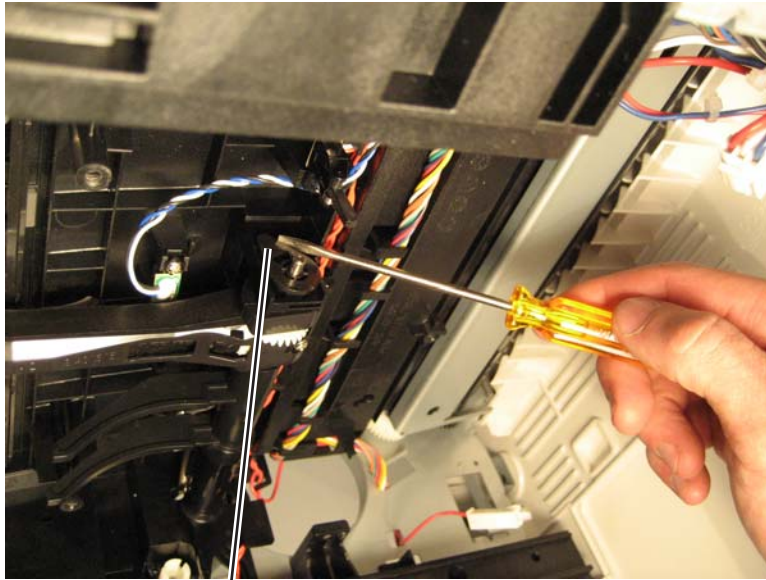

B

9. Remove the inner shaft lock (C).

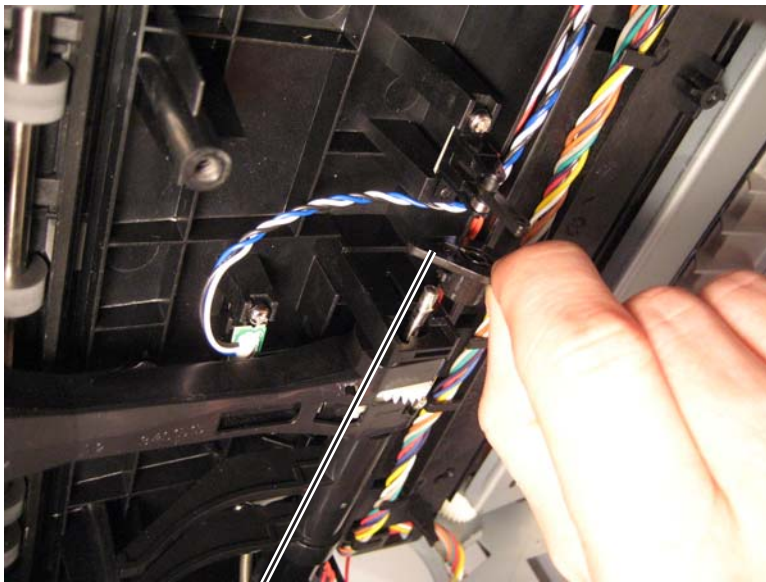

C

10. Pull out the auto compensator shaft, and remove the spring (D).

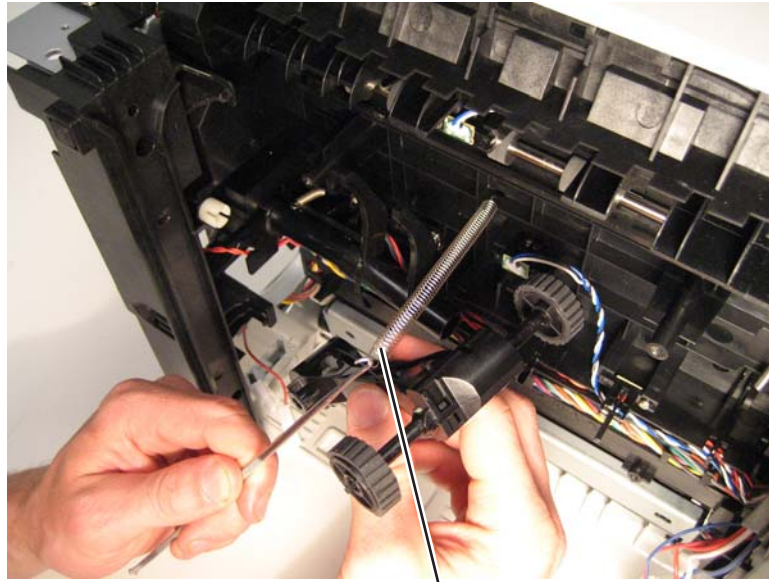

D

11. Remove the auto compensator shaft.
12. Disconnect the spring (E) from the cylinder.

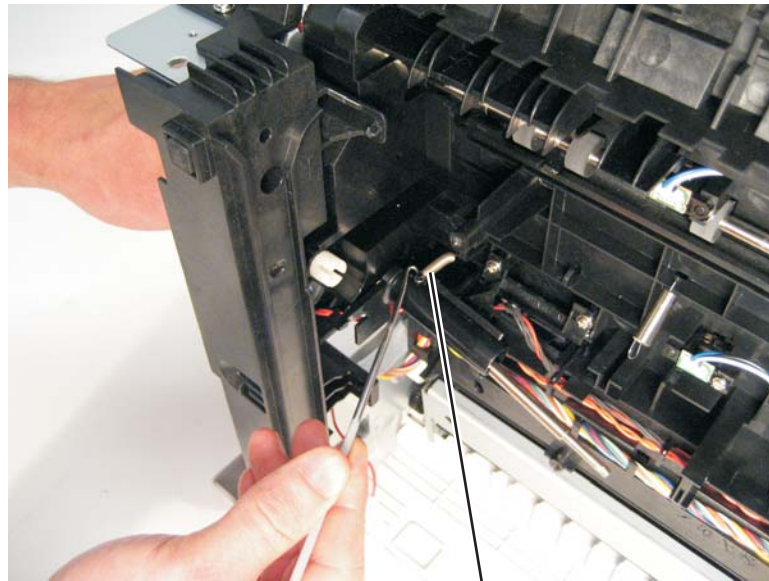

E

13. Remove the media ACM ASM feeder.

Media feed clutch with cable removal

1. Remove the main motor gear drive. See **“Main motor gear drive removal”** on page 4-29.
2. Remove the duplex. See **“Duplex removal”** on page 4-11.
3. Disconnect the media feed clutch cable (A) from the controller board.

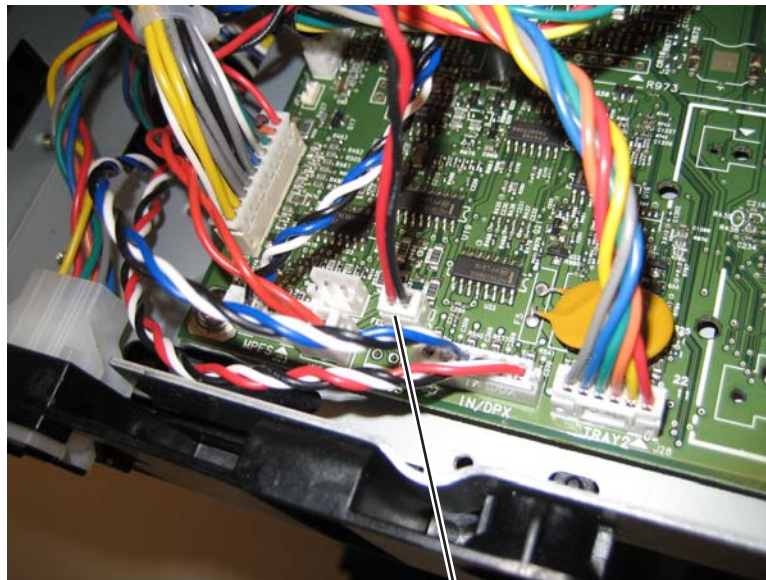

A

4. Unroute the cable from the bottom of the printer.

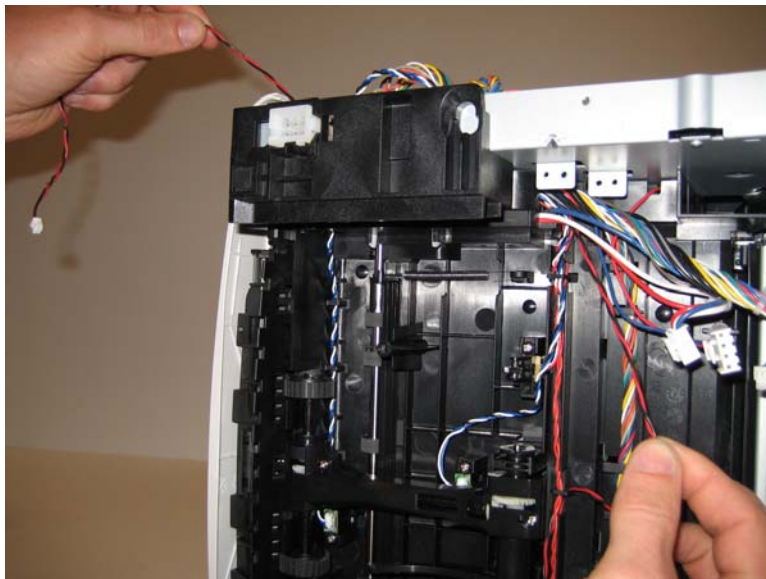

5. Remove the e-clip (B).

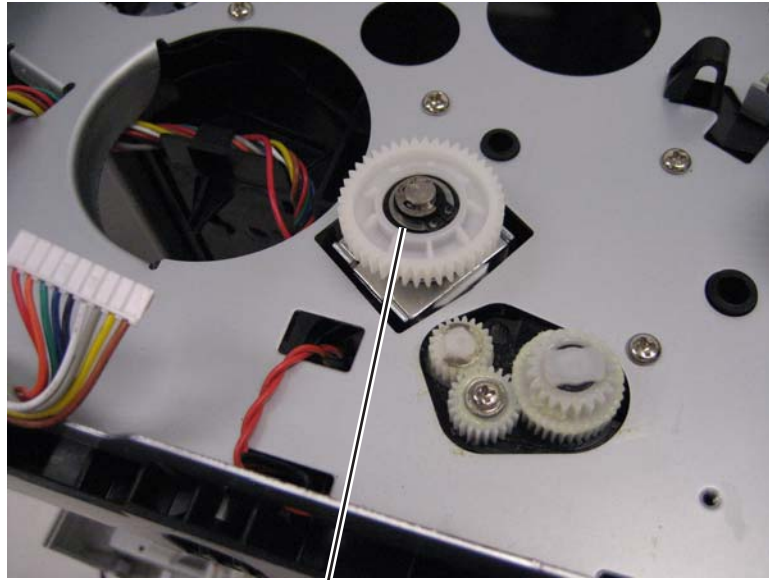

B

6. Remove the media feed clutch with cable (C).

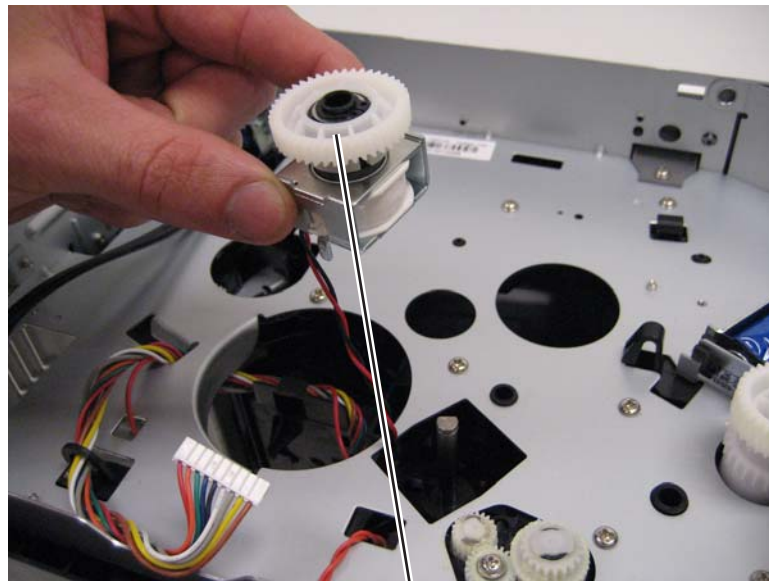

C

Media manual input sensor removal

1. Remove the right side cover. See **“Right side cover assembly removal”** on page 4-51.
2. Place the machine on its top.

Note: Be careful to not mar the finish of the printer.

3. Disconnect the sensor cable (A) from J23 (MPFS) on the controller board.

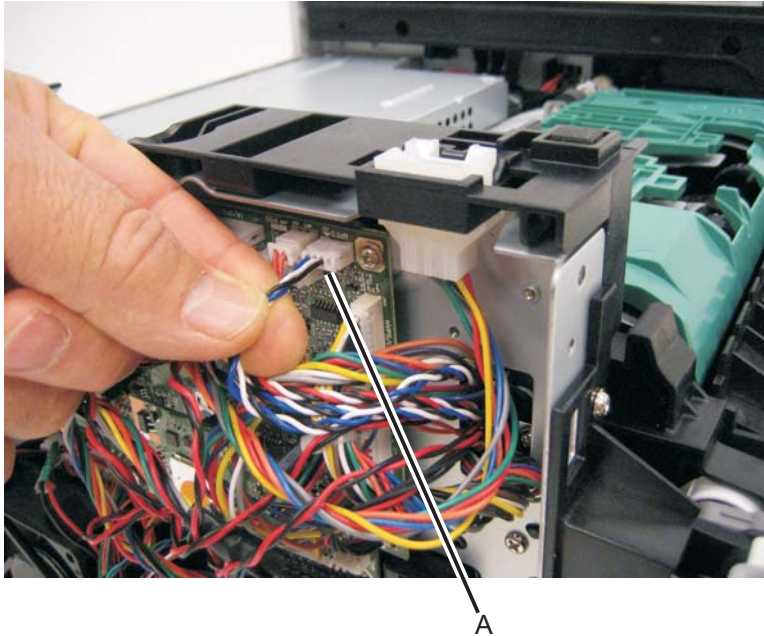

4. Remove the screw (B).

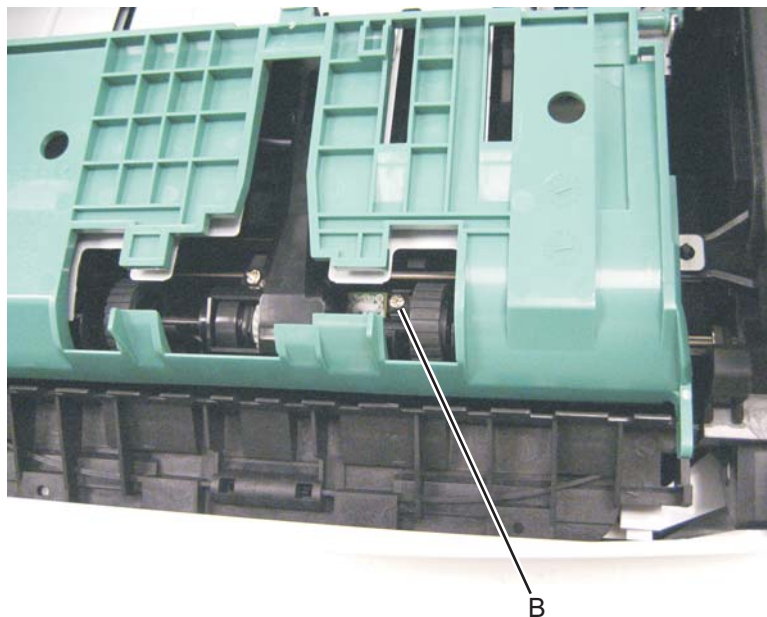

5. Free the cable from its retainers, and pull it through the opening toward the sensor mount.

Re-installation note:

- Prop open the duplex door, and insert the hook end of the spring hook through the frame opening (C) from the controller board side. Extend the hook until the sensor connector can be hooked.
- Hook the spring hook (D) to the connector (E), and pull it through the opening.

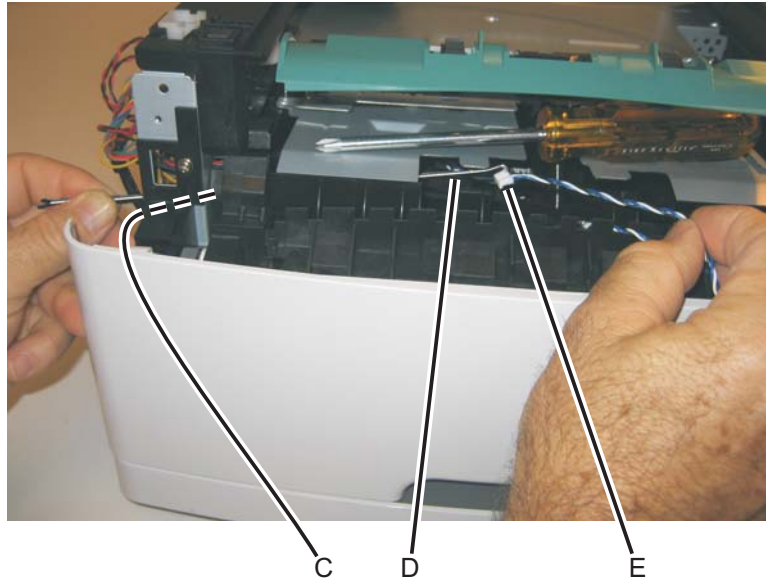

- Place the sensor into position, and reconnect the cable on the controller board.
- Using the spring hook, be sure to reroute the cable through the three retainers (F) between the sensor and side frame.



Note: If the cable is not properly installed in its retainers, then the loose cable will obstruct the paper path.

Warning: Check to make sure the duplex paper jam door is in its proper position. If it is not, then the paper tray will become lodged and the printer will need to be replaced.

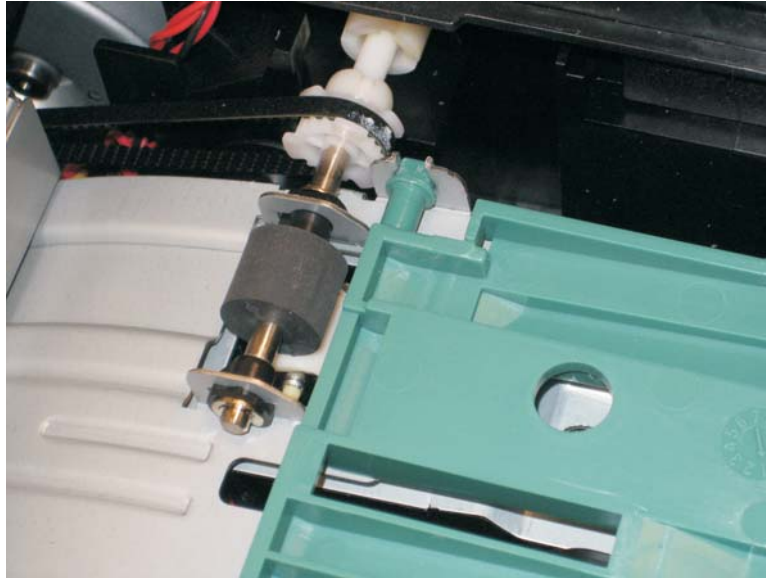

Nameplate removal

1. Open the front access door.
2. Remove the three screws (A).

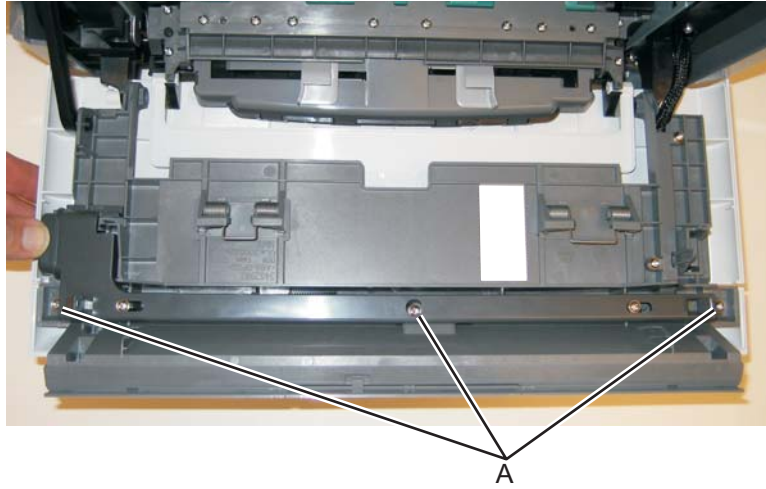

3. Remove the nameplate.

Operator panel removal

1. Remove the nameplate. See **“Nameplate removal”** on page 4-43.
2. Remove the bezel. See **“Bezel removal”** on page 4-5.
3. Remove the four screws (A) from the display plate.



4. Lift the operator panel cover, and disconnect the operator panel cable (B).

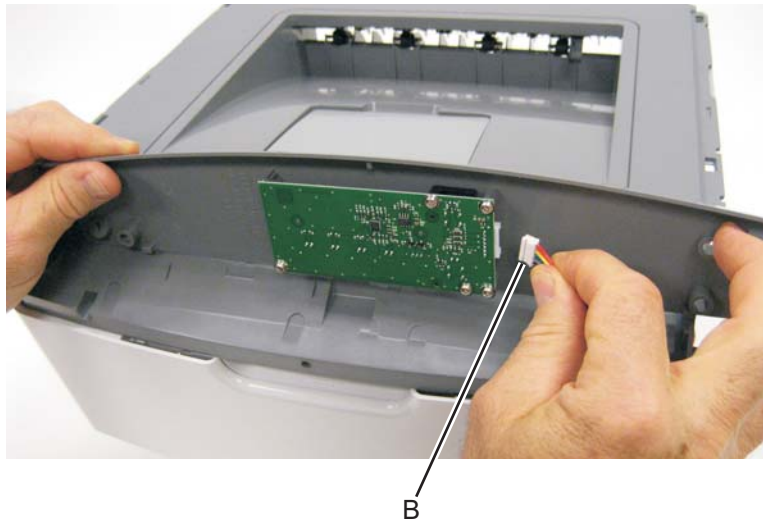

5. Remove the operator panel.

Paper input and duplex sensor assembly removal

1. Remove the right side cover. See **“Right side cover assembly removal”** on page 4-51.
2. Remove the duplex. See **“Duplex removal”** on page 4-11.
3. Remove the two screws (A) from the sensors.

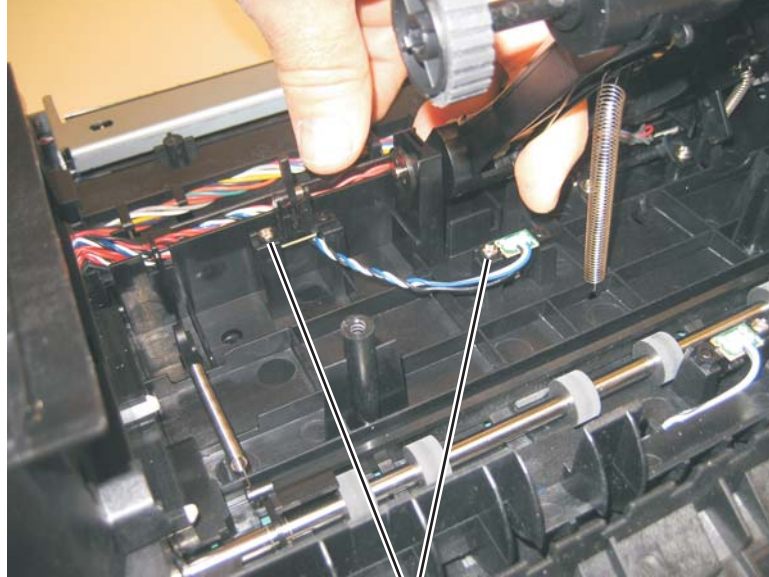

4. Disconnect the sensor cable (B) from the controller board.

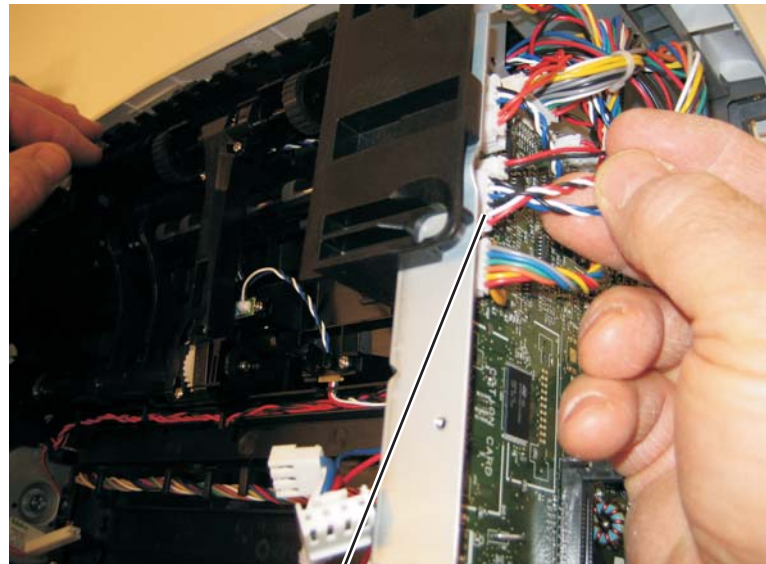

5. Remove the paper input and duplex sensor assembly.

Printhead removal

1. Remove the top cover. See **“Top cover assembly removal”** on page 4-53.
2. Remove the right side cover. See **“Right side cover assembly removal”** on page 4-51
3. Disconnect the two cables (A), and unroute them back through the frame toward the printhead.

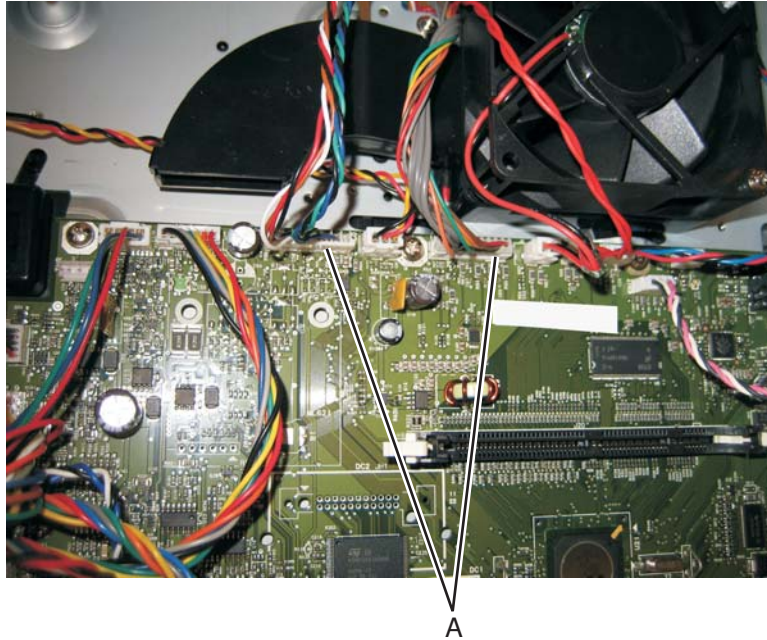

4. Remove the three screws (B).

Note: Use a pencil to mark the screw locations of the printhead on the metal frame. Align the new printhead relative to the location of the old printhead. See **“Adjustment procedures”** on page 3-9.

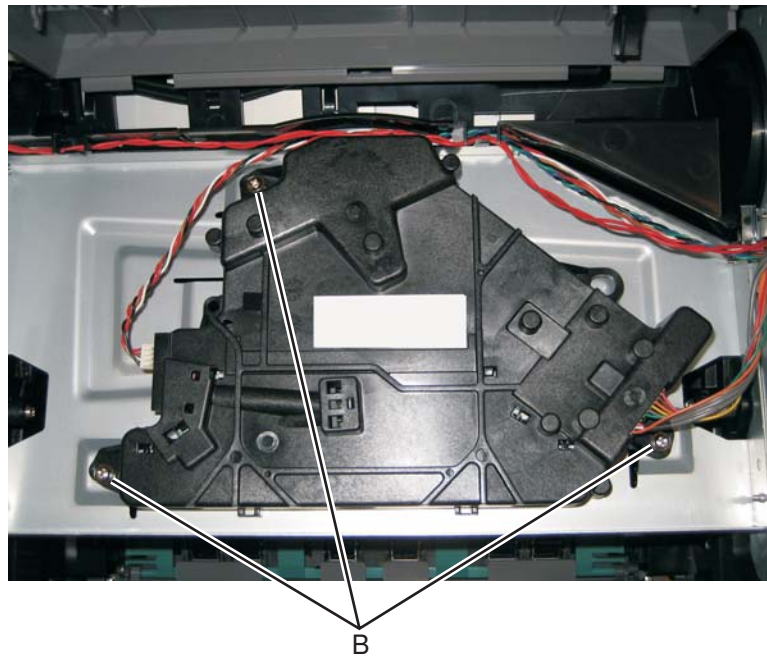

5. Remove the printhead.

Rear door and rear cover removal

1. Open the rear door.
2. Pull the rear door up at an angle, disconnect the door from the notch (A), and remove.



3. Remove the two screws (B) from the top of the rear cover.

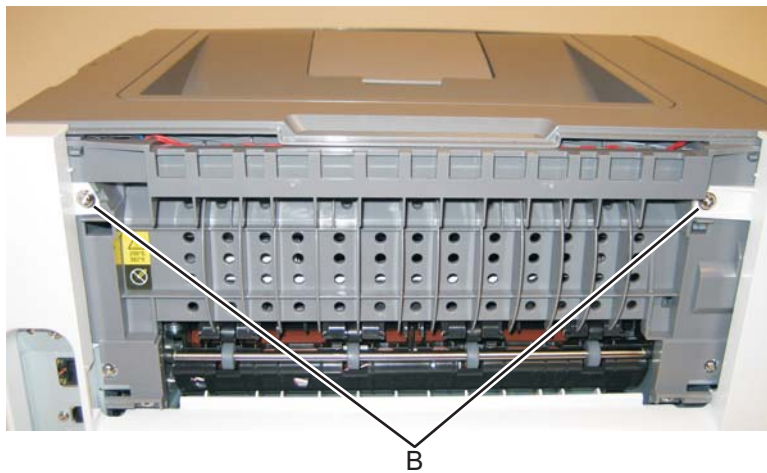

4. Tilt the rear cover, and remove.



Rear exit guide assembly with sensor and reversing solenoid removal

1. Remove the top cover. See **“Top cover assembly removal”** on page 4-53.
2. Remove the rear door and rear cover. See **“Rear door and rear cover removal”** on page 4-47.
3. Disconnect the narrow media sensor cable and the reversing solenoid cable (A).

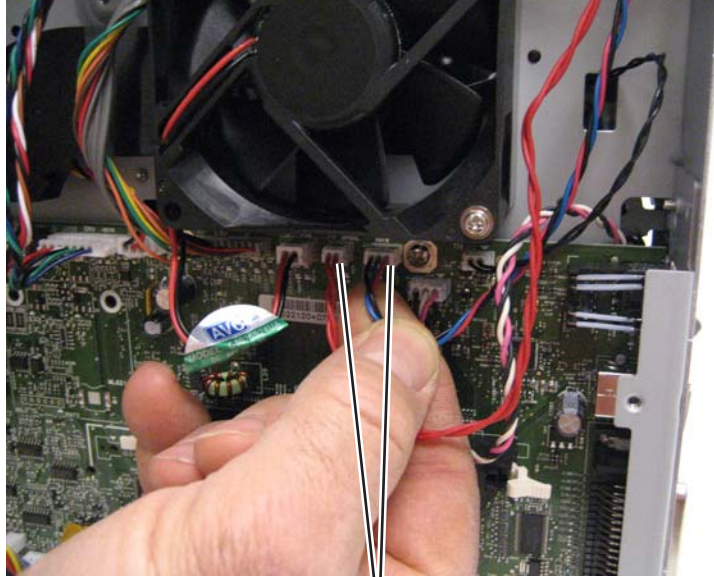

A

4. Remove the six screws (B) from the rear exit guide assembly.

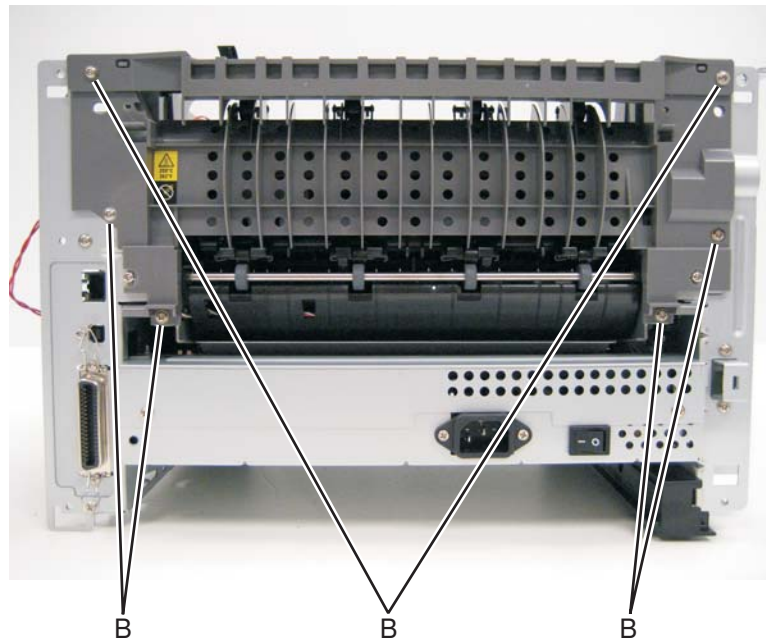

B

B

B

5. Remove the solenoid cable (C) through the opening.

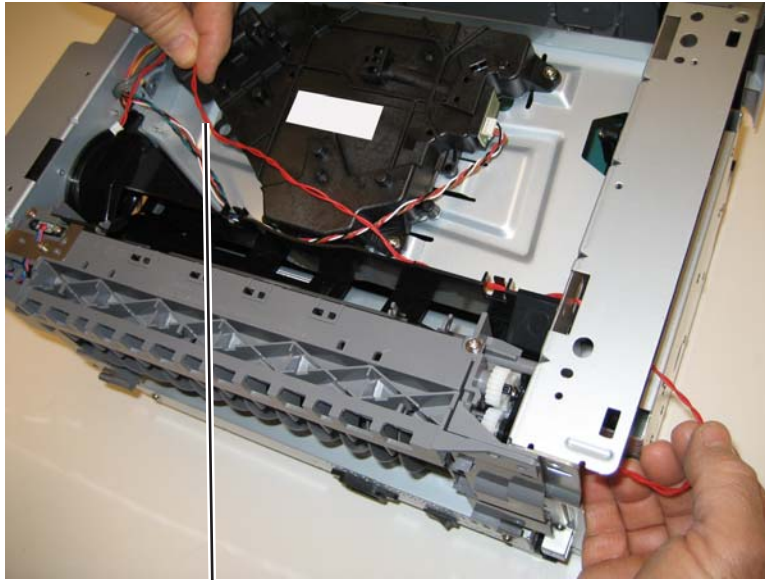

C

6. Remove the narrow media sensor cable (D) through the opening.

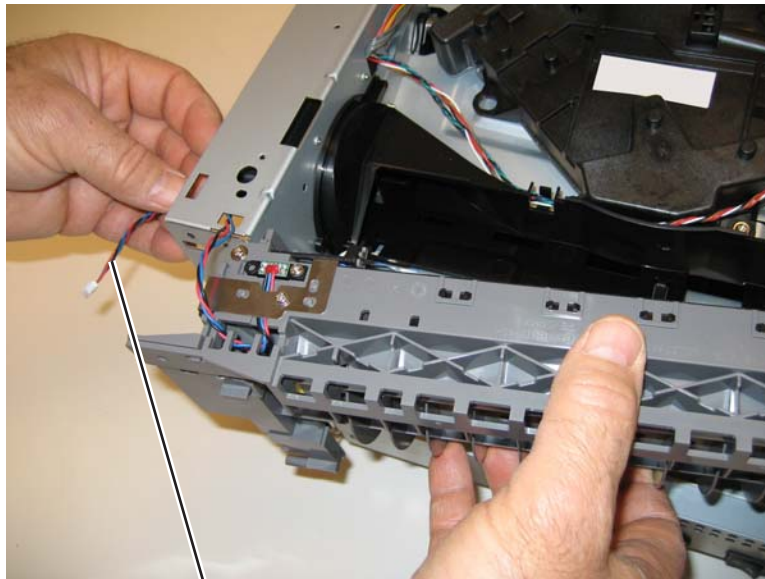

D

7. Remove the rear exit guide assembly.

Note: Be careful to not damage the gears during the rear exit guide assembly removal and reinstallation.

Right side cover assembly removal

Note: Leave the front cover closed when removing the right side cover assembly.

1. Remove the one screw (A) from behind the paper tray.



A

2. Remove the screw (B) from the bottom right side of the printer.



B

3. Press the latches (C).

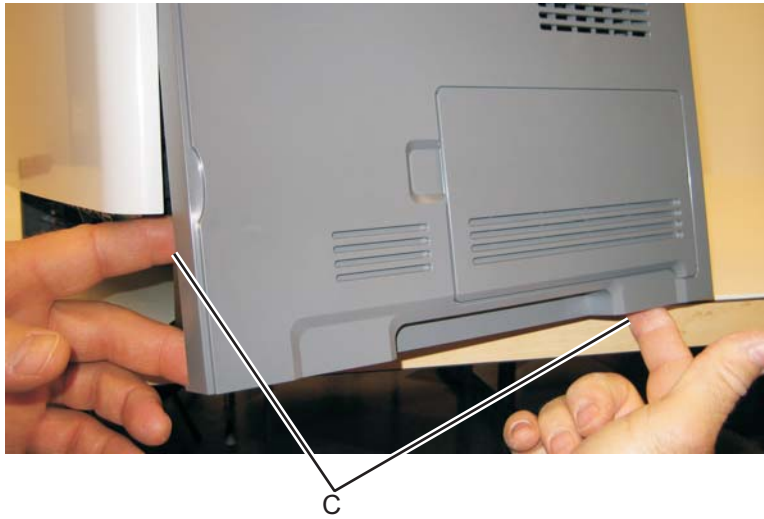

4. Rotate the right side cover assembly out, and remove.



Top cover assembly removal

1. Open the front access door.
2. Remove the left side cover. See **“Left side cover removal” on page 4-23.**
3. Remove the right side cover. See **“Right side cover assembly removal” on page 4-51.**
4. Remove the rear door and rear cover. See **“Rear door and rear cover removal” on page 4-47.**
5. Remove the two screws (A) from the left side of the printer.

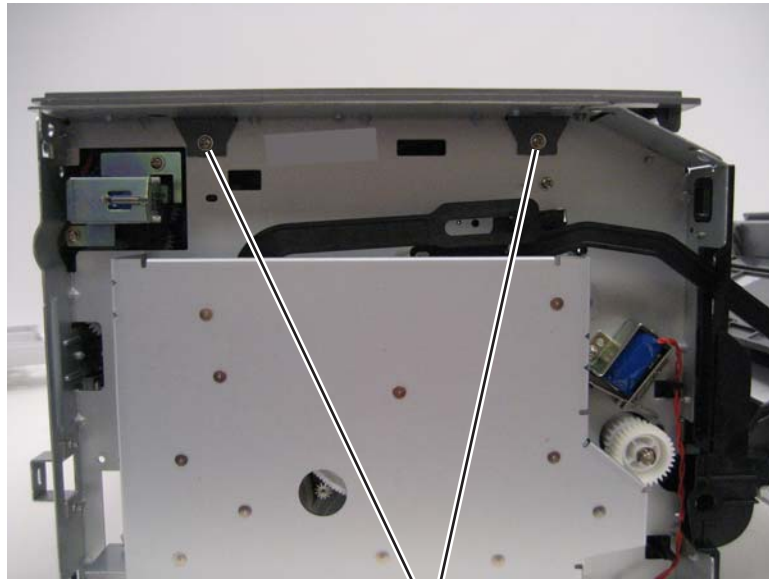

A

6. Remove the two screws (B) from the right side of the printer.

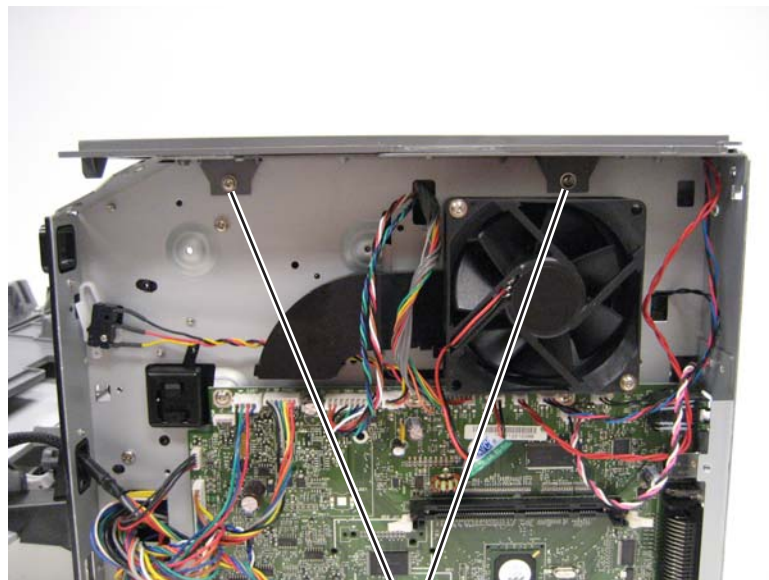

B

7. Lift the top cover, and remove.

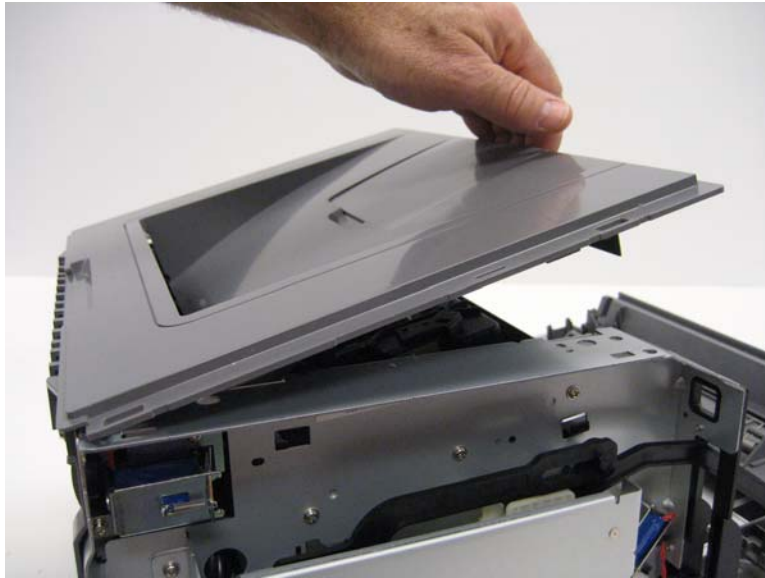

Note:

- Be sure to lift the top cover assembly from the front to remove.
- During reinstallation, be sure the exit guide and the paper bin align correctly. A mismatch can cause paper jams.

Transfer roll removal

Note: A flashlight may be required to remove the transfer roll.

1. Open the front access door.
2. At the right side of the transfer roll, squeeze the holder arms (A) with the left hand while lifting. Stop when the holder is unlatched.

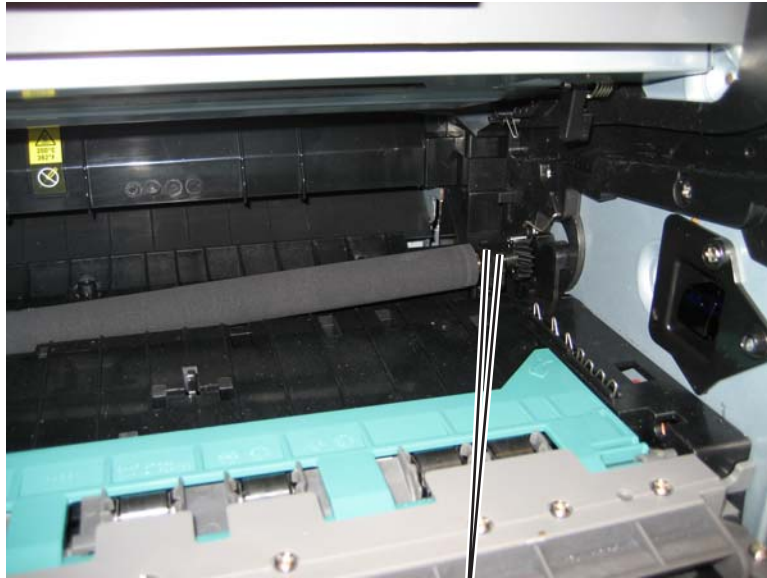

A

3. At the left side of the transfer roll, squeeze the holder arms with the right hand while lifting with the left hand. Stop when the left holder is unlatched.
4. With a hand at each end, lift the transfer roll out.

Note: Do not try removing the spring on the left; it is not removeable but can be dislodged. The spring included with the FRU is to be used only if the old right-side spring is damaged or lost. Both springs must be positioned on posts that cannot be seen. If the old springs are moved, then feel the base of the springs to assure that they are on the posts. The top of the springs must be captured in the bearings of the transfer roll.

Wear strip (tray 1 and 250-sheet tray 2) removal

1. Hold the tray with the bottom up.
2. Use a spring hook to disconnect the strip from the top of the tray.



3. Remove the strip from inside the tray.



Wear strip (550-sheet tray 2) removal

1. Use a spring hook to disconnect the strip from the top of the tray.



2. Lift the strip, and remove.

Note: When replacing the strip (for all trays):

- Carefully insert the strip from the top of the tray, and push it down through the opening until it snaps into place.

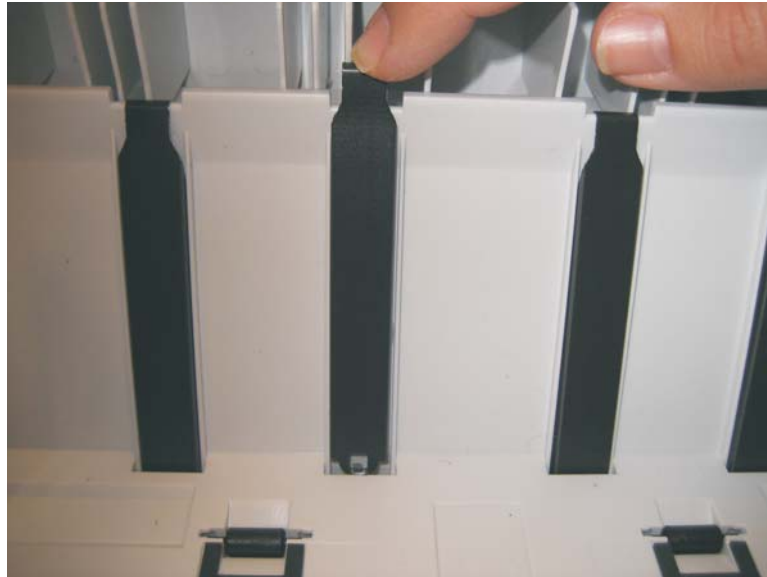

- Turn the tray over to view the bottom of the strip. Using the spring hook, check to make sure that the end of the strip is fastened tightly.
- Be sure that the drafted edge of the strip is installed toward the bottom of the tray.

5. Locations and connections

Locations

Front view

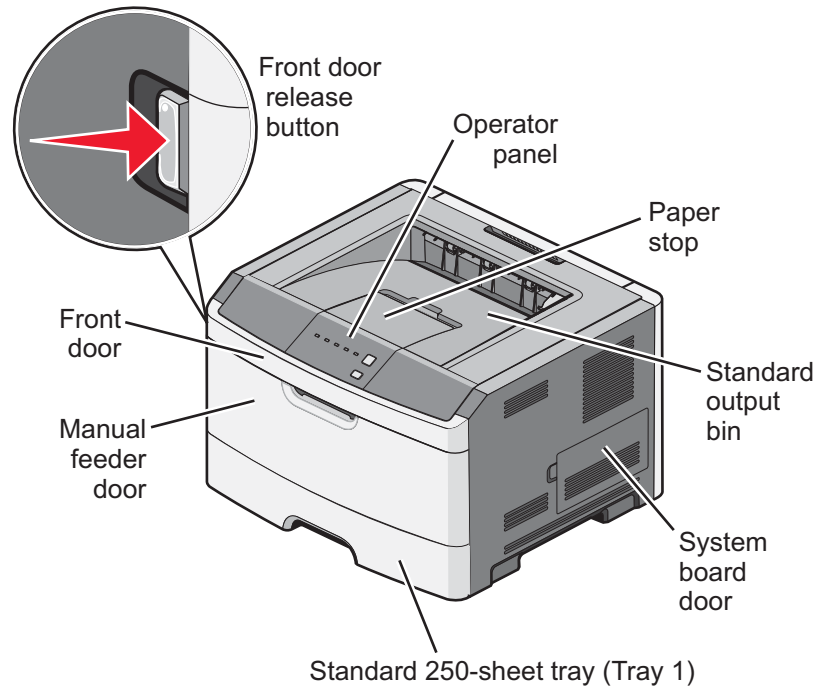

Rear view

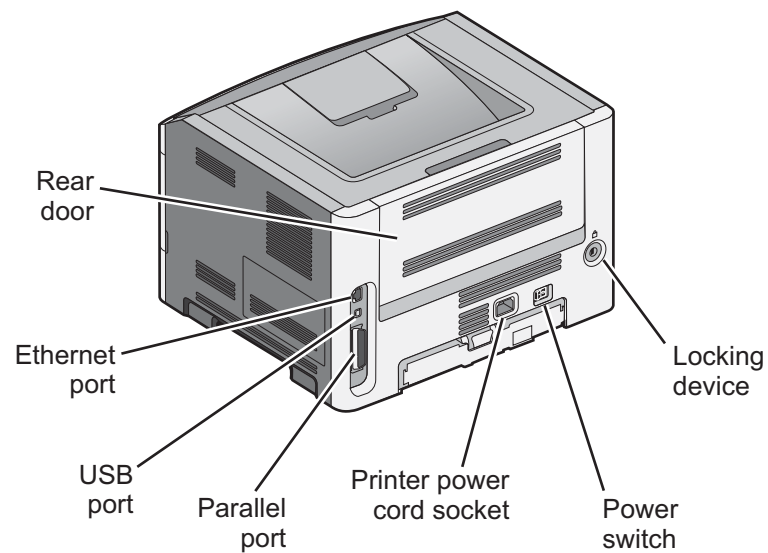

Controller board connector pin values

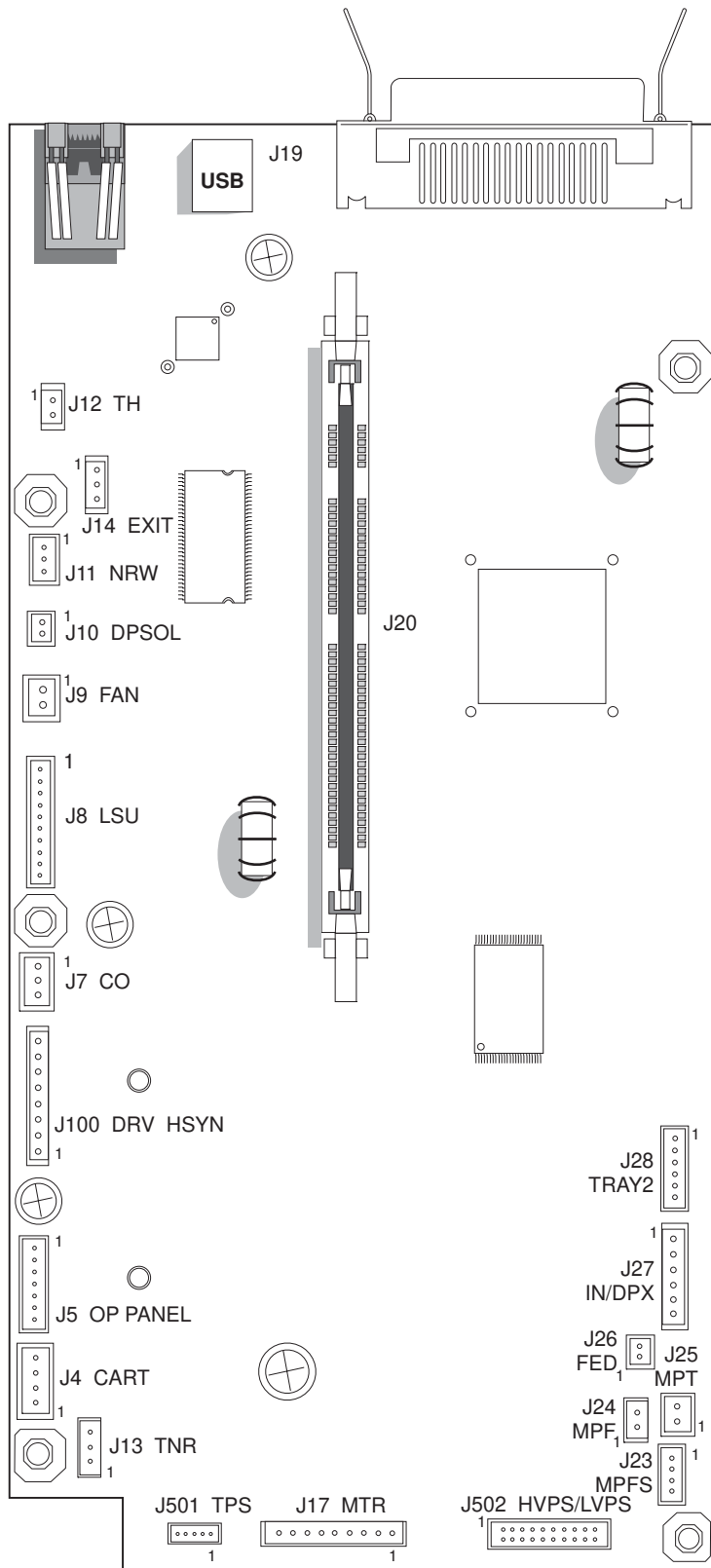

Note: See the wiring diagram at back of book.

These values were measured with all connections made (plugged) or with only one connector at a time unplugged to expose the pins. Always disconnect and connect with the printer power off. Otherwise, the values below may not match.

Connector	Pin #	Value cable plugged	Value cable unplugged (if different)	Comments
J4	1	Ground		Cartridge (The front access door must be closed.)
	2	1.7 V dc		
	3, 4	3.3 V dc		
J5	1, 3, 5, 6	3.3 V dc		Operator panel
	2	5.0 V dc		
	4, 7	Ground		
J100	1	> 0 V dc	5 V dc	Printhead
	2, 3	5 V dc		
	4, 5, 6, 7	Ground		
J7	1	5 V dc (door closed)		Open door sensor
		0 V dc (door open)		
	2	5 V dc		
	3	Ground		
J8	1, 10	5 V dc		LSU
	9	2.9 V dc		
J9	1	24 V dc	0 V dc	Cooling fan
	2	24 V dc		
J10	1	24 V dc	24 V dc	Duplex solenoid
	2	24 V dc	0 V dc	
J11	1		5 V dc	Narrow media sensor
	2	5 V dc	5 V dc	
	3	Ground		
J12	1	5 V dc		Thermistor
	2	Ground		
J14	1	> 0 V dc	5 V dc	Fuser exit sensor
	2	5 V dc		
	3	Ground		
J17	1, 4	0.1 V dc	5 V dc	Main gear drive motor
	2, 3, 6	5 V dc		
	5	Ground		
	7, 8, 9	24 V dc		
J19				USB port
J21				Parallel port

Connector	Pin #	Value cable plugged	Value cable unplugged (if different)	Comments
J23	1	1.1 V dc	5 V dc	Manual feed sensor
	2	5 V dc		
	3	Ground		
J25	1	24 V dc		Manual feed solenoid
	2	24 V dc	0 V dc	
J26	1	24 V dc		Media feed clutch
	2	24 V dc	0 V dc	
J27	1, 4	1.1 V dc	5 V dc	Input and duplex sensor
	2, 5	5 V dc		
	3, 6	Ground		
J28	1, 4	3.3 V dc		Tray 2
	2	24 V dc		
	6	Ground		
J501	1	5 V dc		Toner patch (density) sensor
	3	1 V dc	0 V dc	
	4	Ground		
	5	5 V dc	0V dc	
J502	1, 3, 5, 7, 11, 13, 15		5V dc	LVPS/HVPS
	4		5 V dc	
	6		24 V dc	
	17, 19		24 V dc	
	Other		0 V dc	

6. Preventive maintenance

This chapter describes procedures for printer preventive maintenance. Follow these recommendations to help prevent problems and maintain optimum performance.

Safety inspection guide

The purpose of this inspection guide is to aid you in identifying unsafe conditions.

If any unsafe conditions exist, then find out how serious the hazard could be and if you can continue before you correct the hazard.

Check the following items:

- Damaged, missing, or altered parts, especially in the area of the On/Off switch and the power supply
- Damaged, missing, or altered covers, especially in the area of the top cover and the power supply cover
- Possible safety exposure from any non-Lexmark attachments

Lubrication specifications

FRUs are typically lubricated as needed from the factory. If not, then lubricate only when parts are replaced or as needed, not on a scheduled basis. Use of lubricants other than those specified can cause premature failure. Some unauthorized lubricants may chemically attack parts. Use P/N 99A0394 (Nyogel 744) to lubricate appropriate areas. Lubricate gears that were lubricated in the original part.

7. Parts catalog

How to use this parts catalog

The following legend is used in the parts catalog:

Asm-Index	Part number	Units/mach	Units/FRU	Description
-----------	-------------	------------	-----------	-------------

- **Asm-index:** identifies the assembly and the item in the diagram. For example, 3-1 indicates assembly 3 and the item number 1.
- **Part number:** identifies the unique number that identifies this FRU.
- **Units/mach:** refers to the number of units actually used in the machine or product.
- **Units/FRU:** refers to the number of units packaged together and identified by the part number.
- **NS:** (Not shown) in the Asm-Index column indicates that the part is procurable but is not pictured in the illustration.
- **PP:** (Parts Packet) in the parts description column indicates the part is contained in a parts packet.
- Model information used in the parts catalog.

Machine type and model	Description
4513-220	Lexmark E260d
4513-230	Lexmark E260dn

Assembly 1: Covers

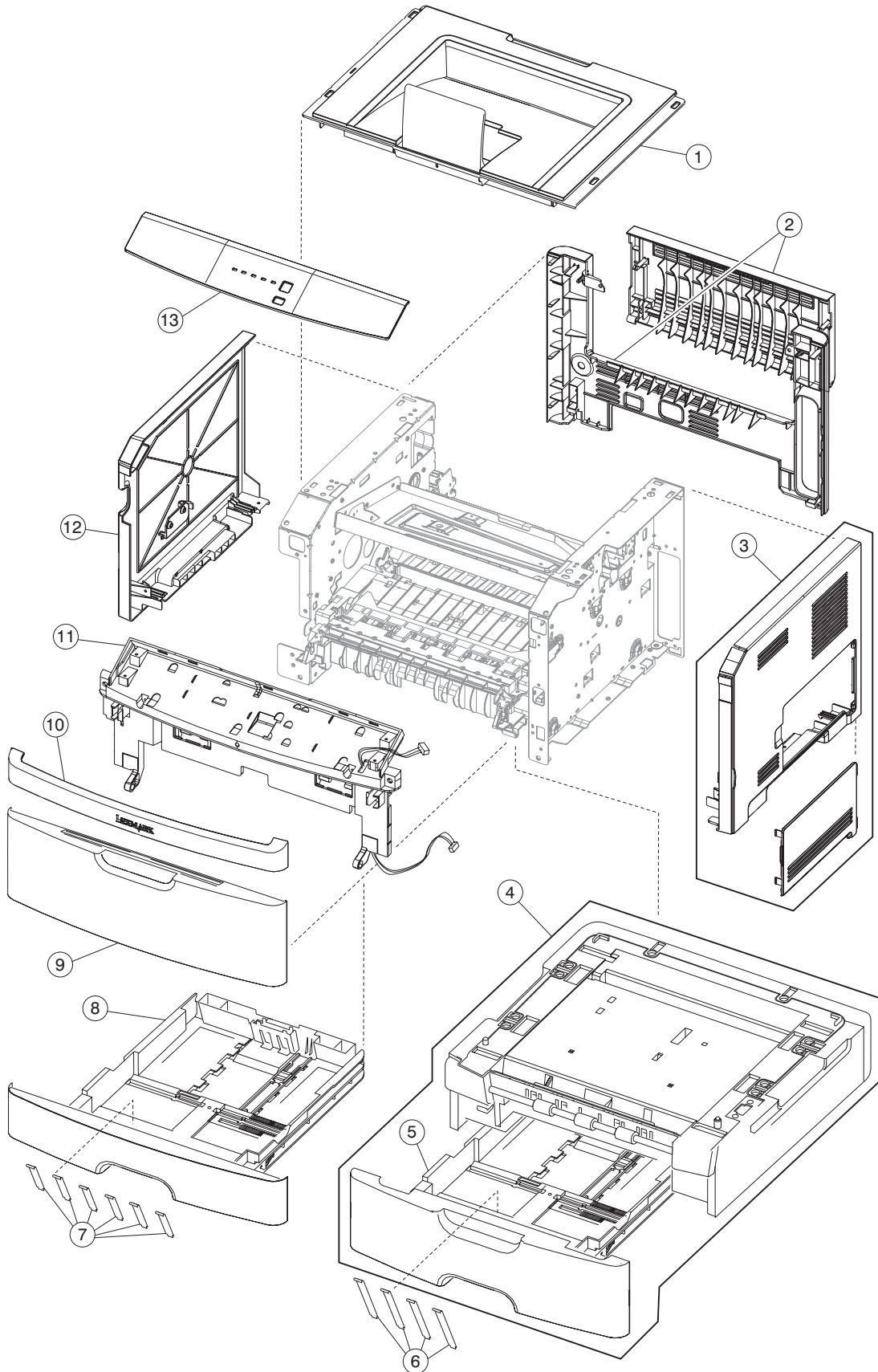

Assembly 1: Covers

Asm-Index	Part number	Units/mach	Units/FRU	Description
1-1	40X5373	1	1	Top cover assembly
2	40X5377	1	1	Rear upper and lower cover assembly
3	40X5375	1	1	Right side cover
4	40X5398	1	1	Optional 250-sheet tray
4	40X5399	1	1	Optional 550-sheet tray
5	40X5394	1	1	250-sheet (Tray 2) assembly
5	40X5395	1	1	550-sheet (Tray 2) assembly
6	40X2855	1	4	Tray 2 wear strips (550-sheet tray only)
7	40X5382	1	6	Wear strips (250-sheet trays, optional and primary)
8	40X5381	1	1	Primary tray
9	40X5379	1	1	Front door cover
10	40X5359	1	1	Nameplate cover
11	40X5378	1	1	Front access door assembly
12	40X5374	1	1	Left side cover
13	40X5353	1	1	LED bezel cover, E260d
13	40X5389	1	1	LED bezel cover, E260dn

Assembly 2: Electronics

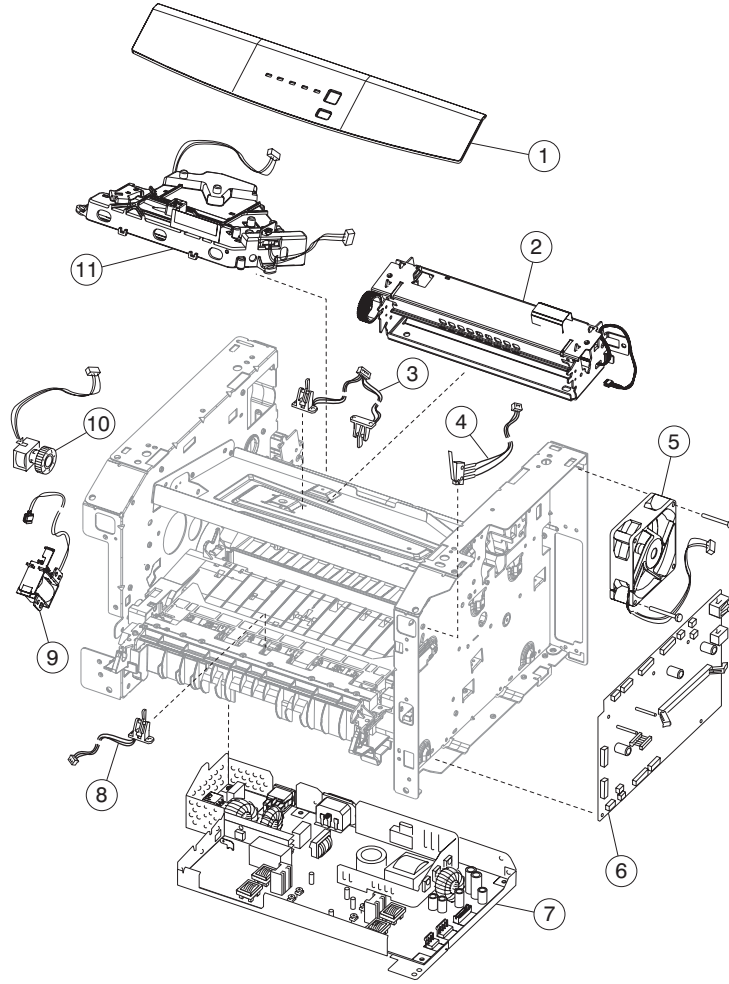

Assembly 2: Electronics

Asm-Index	Part number	Units/mach	Units/FRU	Description
2-1	40X5352	1		LED operator panel assembly, E260d/E260dn
2	40X5344	1		Fuser assembly, 115 V
2	40X5345	1		Fuser assembly, 230 V
2	40X5346	1		Fuser assembly, 100 V
3	40X5365	1	1	Duplex and media sensor assembly
4	40X5360	1	1	Access door open sensor assembly
5	40X5392	1	1	Cooling fan (screws included)
6	40X5347	1	1	Controller board, E260d
6	40X5348	1	1	Controller board, E260dn
7	40X5361	1		LVPS/HVPS card assembly, 110 V/100 V
7	40X5362	1		LVPS/HVPS card assembly, 220 V
8	40X5366	1	1	Manual input sensor assembly
9	40X5369	1	1	Manual feed solenoid
10	40X5370	1	1	Media feed (ACM) clutch
11	40X5387	1		LSU, E260d/E260dn (printhead)

Assembly 3: Frame

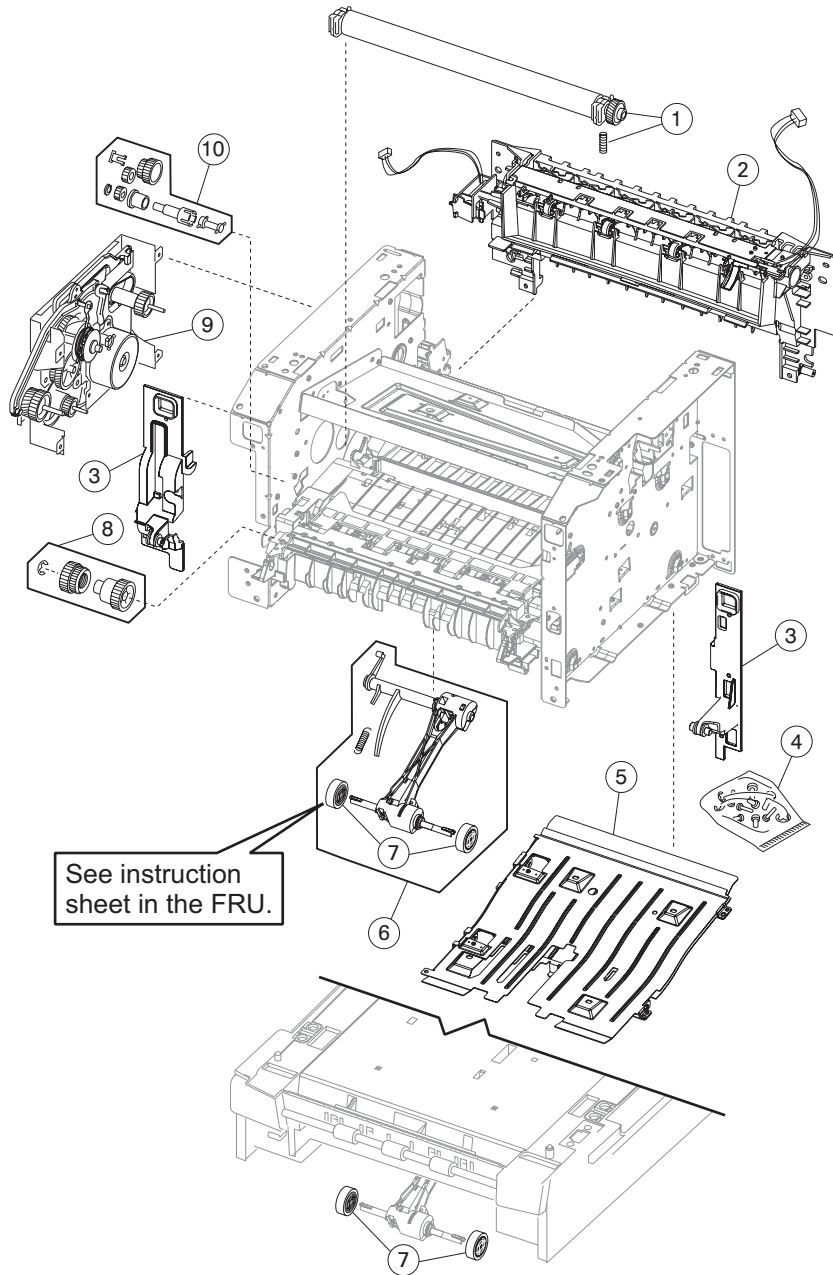

Assembly 3: Frame

Asm-Index	Part number	Units/mach	Units/FRU	Description
3-1	40X5364	1		Transfer roll, bearings, gear, spring (CBM)
2	40X5372	1		Media exit guide assembly (redrive)
3	40X5397	1	1	Front mounts
4	40X5396	N/A		Screws, miscellaneous
			4	TP2NCX3X6PF-Ni
			4	TP2C-4.0+8PF-Ni
			4	M3.0*0.5+6PF-Ni
			2	M3.0*0.5+4PF-Ni
			2	M3.5*0.6+6P-Ni
5	40X5380	1	1	Complete duplex assembly
6	40X5453	1	1	Media (ACM) drive assembly
7	40X5451	2	2	Paper feed, ACM tires
7	40X5440	1	2	Tray 2 paper feed tires
8	40X5368	1	1	Manual feed clutch CBM
9	40X5367	1	1	Main drive gearbox (in motor)
10	40X5363	1	1	Duplex gear drive CBM
NS	7470094	1		Field relocation package assembly

Assembly 4: Options

Asm-Index	Part number	Units/mach	Units/FRU	Description
NS	40X5972	1		Japanese font card assembly
NS	40X5970	1		Simplified Chinese font card assembly
NS	40X5971	1		Traditional Chinese font card assembly
NS	40X5969	1		Korean font card assembly
NS	40X5937	1		128 MB SDR DIMM
NS	40X1367	1		Parallel cable, packaged (3 m)
NS	40X1368	1		USB cable, packaged (2 m)

Assembly 5: Power cords

Asm-Index	Part number	Units/mach	Units/FRU	Description
NS	40X0297	1		Power cord, 1.8M (straight)—USA, Canada
NS	40X0278	1		Power cord, 6 foot (straight)—Europe and others
NS	40X0288	1		Power cord, 8 foot (straight)—Argentina
NS	40X0286	1		Power cord, 8 foot (straight)—United Kingdom
NS	40X0275	1		Power cord, 6 foot (straight)—Israel
NS	40X0274	1		Power cord, 6 foot (straight)—Switzerland
NS	40X0276	1		Power cord, 6 foot (straight)—South Africa
NS	40X0287	1		Power cord, 6 foot (straight)—Traditional Italy
NS	40X0279	1		Power cord, 6 foot (straight)—Denmark
NS	40X0277	1		Power cord, 6 foot (straight)—Brazil
NS	40X0282	1		Power cord, 1.8M (straight)—PRC
NS	40X0270	1		Power cord, 2.5M (straight)—Japan
NS	40X0280	1		Power cord, 1.8M (straight)—Korea
NS	40X0281	1		Power cord, 1.8M (straight)—Taiwan
NS	40X0296	1		Power cord, 1.8M (straight)—Australia

Index

A

abbreviations **1-9**
 acronyms **1-9**
 Auto CR After LF **3-5**
 Auto LF After CR **3-5**

C

compatibility **1-4**
 configuration ID **3-8**
 configuration menu—
 accessing **3-1**
 navigating menu **3-1**
 Network
 Mac Binary PS **3-7**
 NPA Mode **3-7**
 Set Card Speed **3-7**
 Parallel
 MAC Binary PS **3-5**
 NPA Mode **3-5**
 Parallel Mode 2 **3-5**
 Protocol **3-5**
 printing menu **3-2**
 Setup
 Auto CR After LF **3-5**
 Auto LF After CR **3-5**
 Demo Mode **3-5**
 table of light patterns **3-2**
 USB
 Mac Binary PS **3-6**
 NPA Mode **3-6**
 Utilities
 Hex Trace **3-4**
 Print Quality Pages **3-4**
 Reset Factory Defaults **3-4**
 Reset Photoconductor Counter **3-4**
 control panel **1-2**
 controller card
 service check **2-46**

D

Defaults **3-8**
 Demo Mode **3-5**
 diagnostic information **2-1**
 diagnostics mode— **3-1**
 Development
 Configuration ID **3-8**
 Defaults **3-8**
 Edge to Edge **3-8**
 Print History **3-8**
 printout sample **3-3**

E

Edge to Edge **3-8**
 error messages
 primary light patterns **2-3**
 service error codes **2-28, 2-40**
 user attendance messages **2-3**
 ESD-sensitive parts **4-1**

F

fan
 parts catalog **7-5**
 service check **2-47**
 frame, parts catalog **7-6**
 fuser
 parts catalog **7-5**
 service check **2-48**

H

handling ESD-sensitive parts **4-1**
 Hex Trace **2-43, 3-4**

L

light patterns—
 description **2-3**
 primary **2-4**
 service codes **2-28**
 locations
 front views **5-1**
 rear views **5-1**
 lubrication specifications **6-1**
 LVPS/HVPS
 parts catalog **7-5**
 service check **2-49**

M

menus
 configuration menu **3-2**
 diagnostics mode **3-3**
 printing **3-1**
 messages
 service error codes **2-28, 2-40**
 user attendance messages **2-4**
 models
 comparison **1-1**
 diagrams **5-1**
 operator panels **1-2**
 service menus **3-1**
 trays available **1-5**

N

NPA Mode **3-5**

O

- operator panel
 - LED—
 - service check **2-50**
 - overview **1-2**

P

- panel, control **1-2**
- paper jams
 - tips on preventing **1-7**
- parallel port service check **2-52**
- parts catalog
 - covers **7-2**
 - electronics **7-4**
 - frame **7-6**
 - options **7-8**
- power-on self test (POST) **2-2**
 - symptoms **2-44**
- print history **3-8**
- print media
 - preventing jams **1-7**
 - trays by model **1-5**
 - types and sizes **1-6**
- print quality pages **3-4**
 - using **2-53**
- print quality problems
 - print media **1-7**
 - service check **2-53**
 - solving **2-57**
- printer symptom table **2-45**
- printhead
 - service check **2-60**
- Protocol **3-5**

R

- removals
 - covers
 - front access cover **4-6**
 - procedures **4-2**
- Reset Factory Defaults **3-4**
- reset maintenance page counter **3-4**
- Reset PC Counter **3-4**

S

- safety information **xiii**
- safety inspection guide **6-1**
- service checks **2-46**
 - controller card **2-46**
 - cooling fan **2-47**
 - cover interlock switch **2-47**
 - dead machine **2-48**
 - fuser **2-48**
 - LVPS/HVPS **2-49**
 - main motor **2-49**
 - operator panel **2-50**
 - paper feed **2-50**
 - paper jam during POST **2-50**
 - paper never picks **2-51**
 - paper picks but stops **2-51**
 - paper picks during POST **2-50**
 - paper picks sheets **2-51**
 - paper trees, curls **2-52**
- parallel port **2-52**
- print quality **2-53**
 - black page **2-54**
 - blank page **2-53**
 - heavy background **2-54**
 - image density **2-55**
 - light print **2-56**
 - partial blank image **2-55**
 - poor fusing of image **2-55**
 - toner on back of page **2-56**
 - white or black lines **2-56**
- printhead **2-60**
- transfer roll **2-60**
- service error codes **2-40**
 - accessing **2-28**
 - tertiary light patterns **2-30**
- service menus **3-1**
- special tools **1-8**
- specifications
 - connectivity **1-4**
 - input trays **1-5**
 - memory **1-3**
 - operating systems **1-4**
 - photoconductor capacity **1-5**
 - print media **1-6**
 - toner capacity **1-5**
- start **2-1**
- symptom tables **2-44**
 - POST **2-44**
 - printer **2-45**

T

- test pages
 - Print Quality Pages **3-4**
- tools **1-8**
- transfer roll
 - parts catalog **7-7**
 - service check **2-60**

U

- user attendance messages **2-4**

Part number index

40X0270	Power cord, 1.77M (straight)—Japan	7-9
40X0274	Power cord, 6 foot—Switzerland	7-9
40X0275	Power cord, 6 foot (straight)—Israel	7-9
40X0276	Power cord, 6 foot—South Africa	7-9
40X0277	Power cord, 6 foot (straight)—Brazil	7-9
40X0278	Power cord, 6 foot (straight)—Europe and others	7-9
40X0279	Power cord, 6 foot (straight)—Denmark	7-9
40X0280	Power cord, 1.77M (straight)—Korea	7-9
40X0281	Power cord, 1.77M (straight)—Taiwan	7-9
40X0282	Power cord, 1.77M (straight)—PRC	7-9
40X0286	Power cord, 6 foot—United Kingdom	7-9
40X0287	Power cord, 6 foot (straight)—Traditional Italy	7-9
40X0288	Power cord, 6 foot—Argentina	7-9
40X0296	Power cord, 1.8M (straight)—Australia	7-9
40X0297	Power cord, 1.77M (straight)—USA, Canada	7-9
40X1367	Parallel cable, packaged (3 m)	7-8
40X1368	USB cable, packaged (2 m)	7-8
40X2855	Tray 2 wear strips (550-sheet tray only)	7-3
40X5344	Fuser assembly, 115 V	7-5
40X5345	Fuser assembly, 230 V	7-5
40X5346	Fuser assembly, 100 V	7-5
40X5347	Controller board, E260d	7-5
40X5348	Controller board, E260dn	7-5
40X5352	LED operator panel assembly, E260d/E260dn	7-5
40X5353	LED bezel cover, E260d	7-3
40X5359	Nameplate cover	7-3
40X5360	Access door open sensor assembly	7-5
40X5361	LVPS/HVPS card assembly, 110 V/100 V	7-5
40X5362	LVPS/HVPS card assembly, 220 V	7-5
40X5363	Duplex gear drive CBM	7-7
40X5364	Transfer roll, bearings, gear, spring (CBM)	7-7
40X5365	Duplex and media sensor assembly	7-5
40X5366	Manual input sensor assembly	7-5
40X5367	Main drive gearbox (in motor)	7-7
40X5368	Manual feed clutch CBM	7-7
40X5369	Manual feed solenoid	7-5
40X5370	Media feed (ACM) clutch	7-5
40X5372	Media exit guide assembly (redrive)	7-7
40X5373	Top cover assembly	7-3
40X5374	Left side cover	7-3
40X5375	Right side cover	7-3
40X5377	Rear upper and lower cover assembly	7-3
40X5378	Front access door assembly	7-3
40X5379	Front door cover	7-3
40X5380	Complete duplex assembly	7-7
40X5381	Primary tray	7-3
40X5382	Wear strips (250-sheet trays, optional and primary)	7-3
40X5387	LSU, E260d/E260dn (printhead)	7-5
40X5389	LED bezel cover, E260dn	7-3
40X5392	Cooling fan (screws included)	7-5
40X5394	Tray 2 assembly	7-3
40X5395	550-sheet (Tray 2) assembly	7-3
40X5396	Screws, miscellaneous	7-7
40X5397	Front mounts	7-7
40X5398	Optional 250-sheet tray	7-3

4513-220, -230

40X5399	Optional 550-sheet tray	7-3
40X5440	Tray 2 paper feed tires	7-7
40X5451	Paper feed, ACM tires	7-7
40X5453	Media (ACM) drive assembly	7-7
40X5937	128 MB SDR DIMM	7-8
40X5969	Korean font card assembly	7-8
40X5970	Simplified Chinese font card assembly	7-8
40X5971	Traditional Chinese font card assembly	7-8
40X5972	Japanese font card assembly	7-8
7470094	Field relocation package assembly	7-7

E260d/E260dn Wiring Diagram

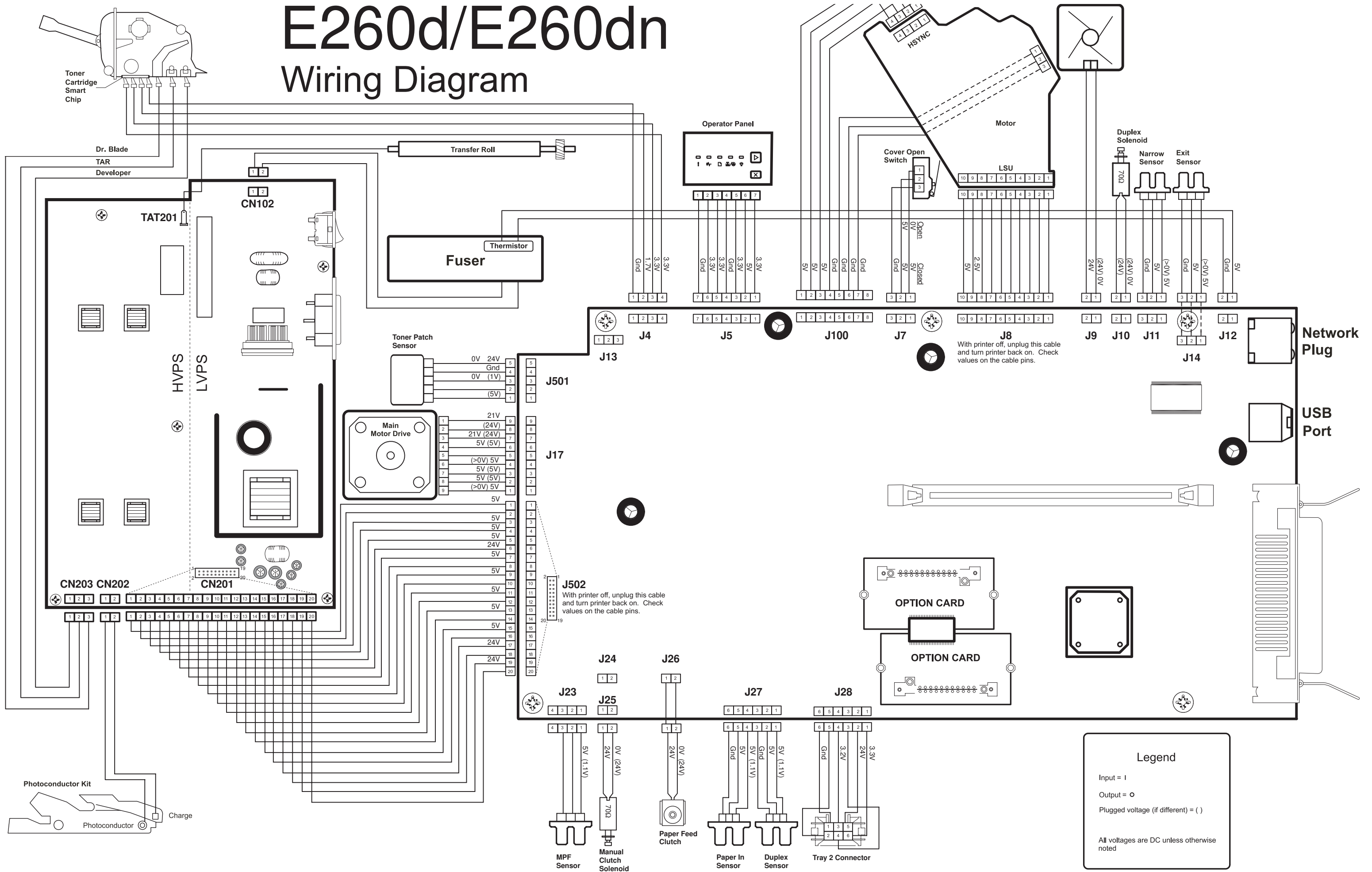



Print Defects guide

Print defects guide

Identifying the cause of repeating defects

Match a set of repeating defects on a print job to the marks on one of the vertical lines shown in the following table. The line that best matches the defects on the print job indicates which particular part is causing the defect.

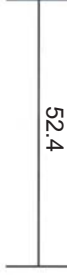
The toner cartridge and the photoconductor kit are customer replaceable items. If the transfer roller or fuser needs replacement, contact Customer Support.

Replace the transfer roller.	Replace the toner cartridge.	Replace the photoconductor kit.		Replace the fuser.	
			or	